

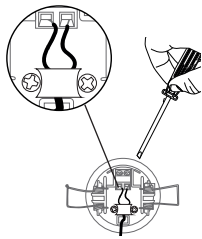
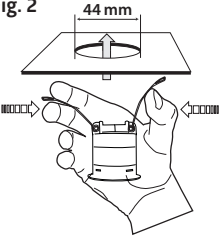
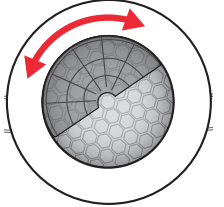
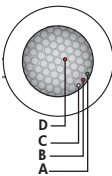

DE Montage-Anleitung Vorbereitung	EN Mounting-Instructions Preparations	FR Montage - Instructions Préparation du montage	NL Montage - Instructies Montagevoorbereiding
<p>! Arbeiten an elektrischen Anlagen dürfen nur von Elektrofachkräften oder von unterwiesenen Personen unter Leitung und Aufsicht einer Elektrofachkraft entsprechend den elektrotechnischen Regeln vorgenommen werden.</p> <p>! Vor Montage Leitung spannungsfrei schalten!</p> <p>! DALI ist nicht SELV – Es gelten die Installationsvorschriften für Niederspannung.</p> <p>! Die DALI-Schraubklemmen dürfen nicht mit der Versorgungsspannung verbunden werden.</p>	<p>! Work on the mains supply may only be carried out by qualified professionals or by instructed persons under the direction and supervision of qualified skilled electrical personnel in accordance with electrotechnical regulations.</p> <p>! Disconnect supply before installing!</p> <p>! DALI is not SELV – the installation instructions for low voltage apply</p> <p>! The DALI screw clamps must not be connected to the supply voltage.</p>	<p>! Travailler sur le réseau électrique ne s'improvise pas, seul un électricien qualifié et habilité doit effectuer ce raccordement.</p> <p>! Avant de commencer l'installation, assurez-vous que l'alimentation est coupée.</p> <p>! DALI est différent de SELV – Les prescriptions d'installation pour basse tension doivent être respectées.</p> <p>! Les bornes DALI ne doivent pas être raccordées à 230 VCA!</p>	<p>! Werkzaamheden aan elektrische installaties mogen enkel door gekwalificeerde installateurs of geschoold personeel uitgevoerd worden en dit in overeenstemming met de elektrotechnische regels.</p> <p>! Netspanning uitschakelen alvorens te beginnen met de montage.</p> <p>! DALI is niet SELV – De installatievoorschriften voor laagspanning zijn van kracht</p> <p>! Alle DALI klemmen mogen niet met de voedingsspanning worden verbonden.</p>
Funktionsweise	Operation	Fonctionnement	Werkwijze
Besonders flacher, adressierbarer DALI-Multisensor mit integriertem DALI-Applikations-Controller.	Especially flat, addressable DALI multisensor with integrated DALI application controller.	Multicapteur DALI adressable extra-plat, avec contrôleur d'application DALI incorporé.	Zeer vlakke, adresseerbare DALI multisensor met geïntegreerde DALI applicatiecontroller.
Das Gerät wird ausschließlich über den DALI-Bus mit Betriebsspannung versorgt. Bewegungen sich Menschen, Tiere oder sonstige Wärmequellen im Erfassungsbereich, schaltet das Gerät vollautomatisch DALI-Leuchten ein. Wird keine Bewegung mehr erkannt, wird das Licht nach 10 Minuten wieder ausgeschaltet. Zur Vergrößerung des Erfassungsbereiches können alle B.E.G. Multisensoren mit der Kennung „DALILINK“ in der Produktbezeichnung eingesetzt werden. Voller Funktionsumfang mit Zubehör aktivierbar.	The device is supplied with operating voltage via the DALI bus. If humans, animals or other sources of heat move in the area of detection, the device automatically switches on DALI lamps. If no movement is detected, the light is switched off again after 10 minutes. To increase the detection range, all B.E.G. Multisensors with the identifier „DALILINK“ in the product description can be used. The complete functional range can only be activated using accessory.	Ce multicapteur est alimenté uniquement par le bus DALI. En cas de mouvements d'une personne, d'un animal ou d'autres sources de chaleur, le multicapteur allume automatiquement les luminaires DALI. Ils seront éteints au bout de 10 minutes s'il n'y a plus de mouvements. Pour élargir la zone de détection, il est possible d'utiliser d'autres multicapteurs de la gamme « DALI LINK ». L'activation de toutes fonctions n'est possible qu'avec accessoire.	Het toestel wordt alleen door de DALI bus gevoed. Als mensen, dieren of andere warmtebronnen binnen de detectiezone bewegen, schakelt het toestel automatisch de DALI verlichting aan. Als geen beweging meer wordt gedetecteerd, wordt het licht na 10 minuten terug uitgeschakeld. Om de detectiezone uit te breiden, kunnen alle B.E.G. multisensoren uit het „DALILINK“ gamma gebruikt worden. Voor een volledig functioneel gebruik zijn de accessoires nodig.
Montage	Mounting	Montage	Montage
<p>Fig. 1</p> 	<p>Fig. 2</p> 	<p>Fig. 3</p> 	<p>Fig. 1: DALI draden met een kleine platte schroevendraaier aansluiten</p> <p>Fig. 2: Toestel in vals plafond inbrengen</p> <p>Fig. 3: Afdeklamellen opklikken om de detectiezone te beperken.</p>
<p>Fig. 1: DALI-Drähte werden mit kleinem Schlitzschraubendreher angeschlossen.</p>	<p>Fig. 1: DALI wires are connected with a small slotted screwdriver.</p>	<p>Fig. 1: Les cables DALI sont a raccorder à l'aide d'un petit tournevis plat.</p>	<p>Fig. 1: DALI draden met een kleine platte schroevendraaier aansluiten</p>
<p>Fig. 2: Gerät wird in Zwischendecke eingeführt.</p>	<p>Fig. 2: Device is inserted into false ceiling.</p>	<p>Fig. 2: Insertion dans un faux plafond</p>	<p>Fig. 2: Toestel in vals plafond inbrengen</p>
<p>Fig. 3: Abdecklamellen zur Einschränkung des Erfassungsbereiches.</p>	<p>Fig. 3: Blinds are clipped to restrict detection area.</p>	<p>Fig. 3: Mise en place des obturateurs</p>	<p>Fig. 3: Afdeklamellen opklikken om de detectiezone te beperken.</p>

	DE LED-Funktionsanzeigen	EN LED function indicators	FR Indicateurs de fonctionnement à LEDs	NL Indicatie LED's
	<ul style="list-style-type: none"> Kurz an: <ul style="list-style-type: none"> A Grün Bewegung (Slave) B Rot Bewegung C Weiß - Dauerhaft an: <ul style="list-style-type: none"> A Grün - B Rot Gerät deaktiviert C Weiß Halbautomatik Blinkt langsam: <ul style="list-style-type: none"> A Grün Lokalisierung B Rot Initialisierung C Weiß Lokalisierung D Rot Lokalisierung Blinkt schnell: <ul style="list-style-type: none"> A Grün Helligkeitssollwert überschritten B Rot - C Weiß - 	<ul style="list-style-type: none"> Shortly on: <ul style="list-style-type: none"> A Green Movement Slave B Red Movement C White - Permanently on: <ul style="list-style-type: none"> A Green - B Red Device disabled C White Semi-automatic Flashing slowly: <ul style="list-style-type: none"> A Green Localisation B Red Initialisation C White Localisation D Red Localisation Flashing fast: <ul style="list-style-type: none"> A Green Light value higher than switch-on threshold B Red - C White - 	<ul style="list-style-type: none"> Allumées (brèvement): <ul style="list-style-type: none"> A Verte Mouvements Esclave B Rouge Mouvements C Blanche - Allumées en permanence: <ul style="list-style-type: none"> A Verte - B Rouge Appareil désactivé C Blanche semi-automatique Clignotement lent: <ul style="list-style-type: none"> A Verte Localisation B Rouge Initialisation C Blanche Localisation D Rouge Localisation Clignotant rapide: <ul style="list-style-type: none"> A Verte Valeur de consigne de luminosité réglé dépassé B Rouge - C Blanche - 	<ul style="list-style-type: none"> Kort aan: <ul style="list-style-type: none"> A Groen Beweging Slave B Rood Beweging C Wit - Permanent aan: <ul style="list-style-type: none"> A Groen - B Rood Toestel gedeactiveerd C Wit Half-automatisch Knippert traag: <ul style="list-style-type: none"> A Groen Localisatie B Rood Initialisatie C Wit Localisatie D Rood Localisatie Knippert snel: <ul style="list-style-type: none"> A Groen Lichtniveau hoger dan de helderheidswaarde B Rood - C Wit -

	EU-Konformitätserklärung	EU Declaration of conformity	Déclaration de conformité UE	EU-Conformiteitsverklaring
	<p>Das Produkt erfüllt die Richtlinien über</p> <ol style="list-style-type: none"> die elektromagnetische Verträglichkeit (2014/30/EU) die Niederspannung (2014/35/EU) die Beschränkung der Verwendung bestimmter gefährlicher Stoffe in Elektro- und Elektronikgeräten (2011/65/EU) 	<p>This product respects the directives concerning</p> <ol style="list-style-type: none"> electromagnetic compatibility (2014/30/EU) low voltage (2014/35/EU) restriction of the use of certain hazardous substances in electrical and electronic equipment (2011/65/EU) 	<p>Ce produit répond aux directives sur</p> <ol style="list-style-type: none"> la compatibilité électromagnétique (2014/30/UE) la basse tension (2014/35/UE) la restriction de l'utilisation de certaines substances dangereuses dans les appareils électriques et électroniques (2011/65/UE) 	<p>Dit product beantwoordt aan de volgende richtlijnen</p> <ol style="list-style-type: none"> Elektromagnetische compatibiliteit (2014/30/EU) Laagspanning (2014/35/EU) Verbod op gebruik van gevaarlijke chemicaliën in elektrische en elektronische apparatuur (2011/65/EU)

	Zubehör	Accessory	Accessoires	Accessoires
92847	SW-DALILINK-BLE-APP	SW-DALILINK-BLE-APP	SW-DALILINK-BLE-APP	SW-DALILINK-BLE-APP
92732	PBM-DALILINK-4W-BLE	PBM-DALILINK-4W-BLE	PBM-DALILINK-4W-BLE	PBM-DALILINK-4W-BLE
92846	PS-DALILINK-DE	PS-DALILINK-FC	PS-DALILINK-FP	PS-DALILINK-IB
93189	PS-DALILINK-USB-REG	PS-DALILINK-USB-REG	PS-DALILINK-USB-REG	PS-DALILINK-USB-REG
92112	IR-PD-DALI-Mini	IR-PD-DALI-Mini	IR-PD-DALI-Mini	IR-PD-DALI-Mini

Reichweite / Produkt Code	Range of coverage / Product Code	Portée / Code produit	Reikwijdte / Productcode
----------------------------------	---	------------------------------	---------------------------------

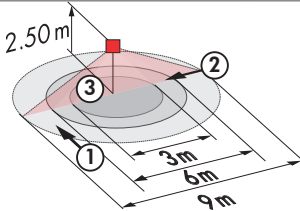



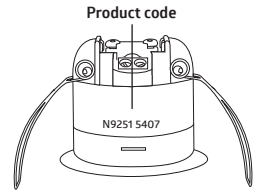

	①	②	③
			
	2.50 m	Ø 9.00 m	Ø 6.00 m

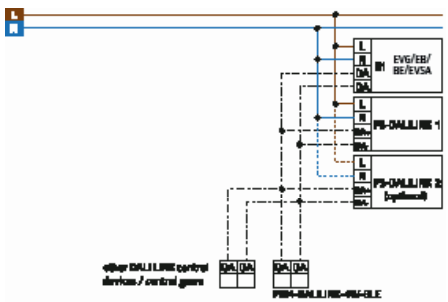
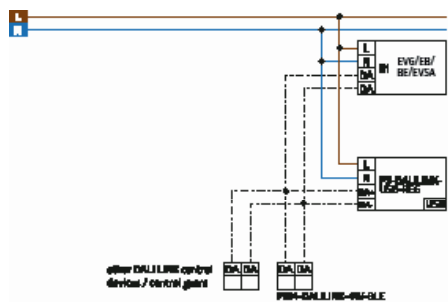

PD11-DALI-LINK-FLAT	Technische Daten	Technical data	Caractéristiques techniques	Technische gegevens
	Parametrierung: über B.E.G. DALI LINK BLE-App	Settings: B.E.G. DALI LINK BLE app	Réglages : par application B.E.G. DALI LINK BLE	Parametriering: via B.E.G. DALI LINK BLE-App
Typ. 16 VDC	Spannung	Voltage	Tension nominale	Spanning
0.1W	Leistungsaufnahme	Power draw	Puissance absorbée	Verbruik
2mA	Stromaufnahme	Typ. power input	Absorption de courant	Nominale stroomopname
0.5 - 2.5 mm²	Anschlussklemmen: für einadrähtige Leiter	Terminal clamps: for solid one-wire conductors	Bornes de raccordement: conducteurs à fil rigide	Aansluitklem: eendradige geleider
II / IP20	Schutzklasse / Schutzart	Class / Degree of protection	Classe / Type de Protection	Klasse / Beschermingsgraad
52 x 48 mm	Abmessungen Ø x H [mm]	Dimensions Ø x H [mm]	Dimensions Ø x H [mm]	Afmetingen Ø x H [mm]
2.5 m -25°C - +50°C	Reichweite bei Montagehöhe Umgebungstemperatur	Range of coverage at mounting height Ambient temperature	Portée pour une hauteur de montage de température ambiante	Bereik op montagehoogte Omgevingstemperatuur
① = Ø 9 m ② = Ø 6 m ③ = Ø 3 m	1 quer 2 frontal 3 kleinere Bewegungen	1 access 2 towards 3 smaller movements	1 transversale 2 frontale 3 petits mouvements	1 dwars 2 frontal 3 kleinere bewegingen
Polycarbonat(e)	Gehäuse	Housing	Boîtier	Behuizing
1 s - 120 min	Nachlaufzeit	Follow-up time	Durée de temporisation	Nalooptijd
5 % - 100 % / 1 min - 120 min/∞	Orientierungslicht	Orientation light	Lumière d'orientation	Oriëntatieverlichting
10 - 2500 Lux	Helligkeitssollwert	Brightness set value	Valeur de consigne de luminosité	Helderheidswaarde

<p>Schematisches Schaltbild – Bitte beachten Sie beim Anschließen die Beschriftung der Klemmen am Gerät!</p>	<p>Schematic diagram - when connecting the detector, please respect the labelling of the terminal connections at the device!</p>	<p>Schéma de raccordement de base – veuillez respecter le marquage des bornes sur l'appareil !</p>	<p>Aansluitschema – respecteer de labelling van de klemmen bij het aansluiten van het apparaat!</p>
			

DE Fehlersuche	EN Troubleshooting	FR Dépannages	NL Foutopsporing
<p>1. Zu hoher Stromverbrauch an DALI-Linie</p> <p>Berücksichtigen Sie bitte bei Ihrem System die Gesamtstromaufnahme aller DALI-Einheiten.</p>	<p>1. Power consumption on DALI line too high</p> <p>Please be aware of the total power consumption of all the DALI units in your system.</p>	<p>1. Surc consommation sur la ligne DALI</p> <p>Vérifier la consommation totale de l'ensemble de vos produits DALI.</p>	<p>1. Hoog verbruik op DALI bus</p> <p>Hou aub rekening met de totale stroomopname van alle DALI toestellen in uw systeem.</p>
<p>2. Wärmequellen in der näheren Umgebung</p> <p>Befindet sich der Melder zu Beispiel in unmittelbarer Nähe von Lüftungsschlitzen oder einem Projektor, können die daraus entstehenden warmen Luftströmungen eine Bewegungsdetektion auslösen. Platzieren Sie den Melder in ausreichend großer Entfernung zu potentiellen Störquellen wie Lüftungsschlitzen, Projektoren, Beamern, Kopierern, Druckern, etc.</p>	<p>2. Heat sources in the vicinity</p> <p>If, for example, the detector is located in the immediate vicinity of ventilation slits or a projector, the warm air currents can trigger motion detection. Place the detector at a sufficient distance from potential sources of interference such as ventilation slits, projectors, beamers, copiers, printers, etc.</p>	<p>2. Sources de chaleur à proximité</p> <p>Si, par exemple, le détecteur est proche d'une source de perturbation (ventilation, luminaire...), l'air chaud peut provoquer une détection de mouvement. Veuillez placer le détecteur dans une distance suffisante des sources d'interférences comme ventilation, projecteurs, vidéo-projecteurs, photocopieuses, imprimantes etc.</p>	<p>2. Warmtebronnen in de buurt</p> <p>Als de detector in de onmiddellijke omgeving van ventilatieopeningen of een projector is geplaatst, kan de warme luchtstroom de bewegingsmelder activeren. Plaats de detector op voldoende afstand van mogelijk stoorbronnen zoals ventilatieopeningen, projectoren, beamers, kopieerapparaten, printers, enz.</p>
<p>Erweiterte Funktionen</p> <p>Die Erläuterungen aller Funktionen finden Sie in der Funktionsbeschreibung:</p>  <p>www.beg-luxomat.com/de</p>	<p>Additional functions</p> <p>An explanation of all functions can be found in the operation manual:</p>  <p>www.beg-luxomat.com/en</p>	<p>Fonctions supplémentaires</p> <p>Les explications concernant toutes les fonctions se trouvent dans le descriptif de fonction :</p>  <p>www.beg-luxomat.com/fr</p>	<p>Extra functies</p> <p>Alle functieomschrijvingen vindt u terug in de handleiding:</p>  <p>www.beg-luxomat.com/nl</p>



92112 – IR-PD-DALI-Mini



92732 – PBM-DALILINK-4W-BLE



92846 – PS-DALILINK



93189 – PS-DALILINK-USB-REX



92833 – UP-Adapter Set/FM-Adapter set/Adaptateur EN/VZ Adapter Set

B.E.G. **Brück Electronic GmbH**
Gerberstr. 33 • D-51789 Lindlar
Telefon: +49 (0) 2266.90121-0
Fax: +49 (0) 2266.90121-50
E-Mail: info@beg.de
Internet: www.beg-luxomat.com