

B.E.G.

LUXOMAT® net

KNX Universal dimming actuator, 4-gang



DIM4-230/UNI/250/H/KNX REG

Operating Manual

90222

All device data can also be found here:



<https://beg-luxomat.com/qr.php?prtno=90222>

© 2019

B.E.G. Brück Electronic GmbH Gerberstraße 3351789 Lindlar GERMANY

Phone: +49 (0) 2266 90121-0 Fax: +49 (0) 2266 90121-50

E-mail: info@beg.de Internet: www.beg-luxomat.com

1	About this document	3
1.1	Other applicable documents	3
1.2	Used symbols and signal words	3
2	Safety	3
2.1	Intended use	3
2.2	Foreseeable misuse	5
2.3	Qualified persons / electricians	5
2.3.1	Certified electricians	6
2.4	Disclaimer	6
3	Device description	7
3.1	Device overview	7
3.2	Function	7
3.2.1	System information	7
3.2.2	Product characteristics	8
4	Operation	9
4.1	Operating elements	9
4.2	Status indication	9
4.3	Operating modes	10
4.4	Manual mode	10
4.4.1	Switching on the temporary manual mode	10
4.4.2	Switching off temporary manual mode	10
4.4.3	Switching on permanent manual mode	10
4.4.4	Switching off permanent manual mode	11
4.5	Operating the outputs	11
4.5.1	Switching off all outputs	11
4.5.2	Disabling individual outputs	11
4.5.3	Re-enabling outputs	12
5	Mounting	13
5.1	Mounting the device	13
5.2	Cover for KNX bus connector	14

6	Electrical connection	15
6.1	Clampable conductor cross-sections	15
6.2	Standard connection	16
6.3	Parallel connection of outputs – connecting lamp load up to 950 W	18
6.4	Installing power boosters	19
7	Commissioning	20
7.1	KNX programming mode	20
7.2	Commissioning via ETS	20
7.2.1	ETS product database	20
7.3	Calibration procedure	21
8	Care, maintenance and disposal	22
8.1	Cleaning	22
8.2	Maintenance	22
8.3	Disposing	22
9	Diagnostics and troubleshooting	23
9.1	Troubleshooting	23
9.2	Diagnosis via the ETS	25
10	Service and support	26
10.1	Manufacturer's warranty	26
10.1.1	Product code	26
10.2	Contact details	26
11	Technical Data	27
11.1	General data	27
11.2	Dimensioned drawing DIM4-230/UNI/250/H/KNX REG	28
12	EU declaration of conformity	29

1 About this document

1.1 Other applicable documents

Short operating manual

90222M1_Short_MAN_DIM4-230_UNI_250_H_KNX REG_90401_de_en_fr_nl_V1



(supplied with the device).

KNX application description

W90222_Appl_MAN_DIM4-230_UNI_250_H_KNX REG_en_V1

(download from website).

1.2 Used symbols and signal words

	Symbol indicating possible dangers to persons
	Symbol indicating possible property damage
	Symbol for useful information and tips
NOTICE	Signal word for possible property damage
CAUTION	Signal word for possible minor injuries
WARNING	Signal word for possible serious injuries
DANGER	Signal word for possible fatal injuries

2 Safety

The KNX universal dimming actuator DIM4-230/UNI/250/H/KNX REG was developed, manufactured and tested in accordance with the applicable safety standards. It corresponds to the state of the art.

2.1 Intended use

The device is an universal dimming actuator for KNX TP for indoor installation in the sub-distribution cabinet. It is used for switching and dimming of

- incandescent lamps
- HV halogen lamps
- dimmable HV-LED lamps
- dimmable compact fluorescent lamps
- dimmable inductive transformers with LV halogen or LV LED lamps, dimmable electronic transformers with LV halogen or LV LED lamps

Mounting on DIN rail according to EN 60715 in sub-distribution cabinets.

⚠ CAUTION**Observe intended use!**

The protection of personnel and the device cannot be guaranteed if the device is operated in a manner not complying with its intended use.

- Only operate the device in accordance with its intended use.
- B.E.G. Brück Electronic GmbH is not liable for damages caused by improper use.
- Read these operating instructions before commissioning the device. Knowledge of the operating instructions is an element of proper use.

NOTICE**Comply with conditions and regulations!**

- Observe the locally applicable legal regulations and the rules of the employer's liability insurance association.

⚠ WARNING

Work on electrical equipment may only be carried out by certified electricians or by instructed persons under the direction and supervision of a certified electrician in accordance with the electrical engineering regulations.

Serious injuries, fire or property damage possible.

- Please read and follow manual fully.

Danger of electric shock.

Device is not suitable for disconnection from supply voltage.

The load is not electrically isolated from the mains even when the output is switched off.

Danger of electric shock.

- Before working on the device or before exchanging light bulbs, disconnect mains voltage and switch off circuit breakers.
- Do not connect any LED or compact fluorescent lamps that are not specifically suitable for dimming. Device can be damaged.
- Do not connect any lights with integrated dimmers. Device can be damaged.

Fire hazard.

For operation with inductive transformers, each transformer must be fused on the primary side in accordance with the manufacturer's instructions. Only safety transformers according to EN 61558-2-6 may be used.

These instructions are an integral part of the product, and must remain with the end customer.

⚠ CAUTION**Observe loads and dimming principle!**

→ If inductive or electronic transformers are connected, observe the data of the transformer manufacturer on loads and the dimming principle.

HV-LED and compact fluorescent lamps generate high pulsed currents, when they are operated in the leading edge phase control.

Dimming results and dimming quality could vary depending on cable lengths, grid conditions and other influencing factors. Depending on the design and power rating of the lamps, the connected load of the specified values could vary.

We do not assume any responsibility for the function, dimming results and dimming quality in connection with LED lamps and will not accept any liability.

2.2 Foreseeable misuse

Any use other than that defined under "Intended use" or which goes beyond that use is considered improper use.

In particular, use of the device is not permitted in the following cases:

- in rooms with explosive atmospheres
- in circuits which are relevant to safety
- for medical purposes

NOTICE**Do not modify or otherwise interfere with the device!**

→ Do not carry out modifications or otherwise interfere with the device. The device must not be tampered with and must not be changed in any way.

→ The device must not be opened. There are no user-serviceable parts inside.

→ Repairs must only be performed by B.E.G. Brück Electronic GmbH.

2.3 Qualified persons / electricians

Connection, mounting, commissioning and adjustment of the device must only be carried out by competent persons.

Prerequisites for competent persons:

- They have a suitable technical education.
- They are familiar with the rules and regulations for occupational safety and safety at work.
- They are familiar with the operating instructions for the device.
- They have been instructed by the responsible person on the mounting and operation of the device.

2.3.1 Certified electricians

Work on electrical equipment may only be carried out by certified electricians or by instructed persons under the direction and supervision of a certified electrician in accordance with the electrical engineering regulations.

Due to their technical training, knowledge and experience as well as their familiarity with relevant standards and regulations, certified electricians are able to perform work on electrical systems and independently detect possible dangers.

In Germany, certified electricians must fulfill the requirements of accident-prevention regulations DGUV (German Social Accident Insurance) provision 3 (e.g. electrician foreman). In other countries, there are respective regulations that must be observed.

2.4 Disclaimer

B.E.G. Brück Electronic GmbH is not liable in the following cases:

- The device is not being used properly.
- Reasonably foreseeable misuse is not taken into account.
- Mounting and electrical connection are not properly performed.
- Changes (e.g., constructional) are made to the device.

3 Device description

3.1 Device overview

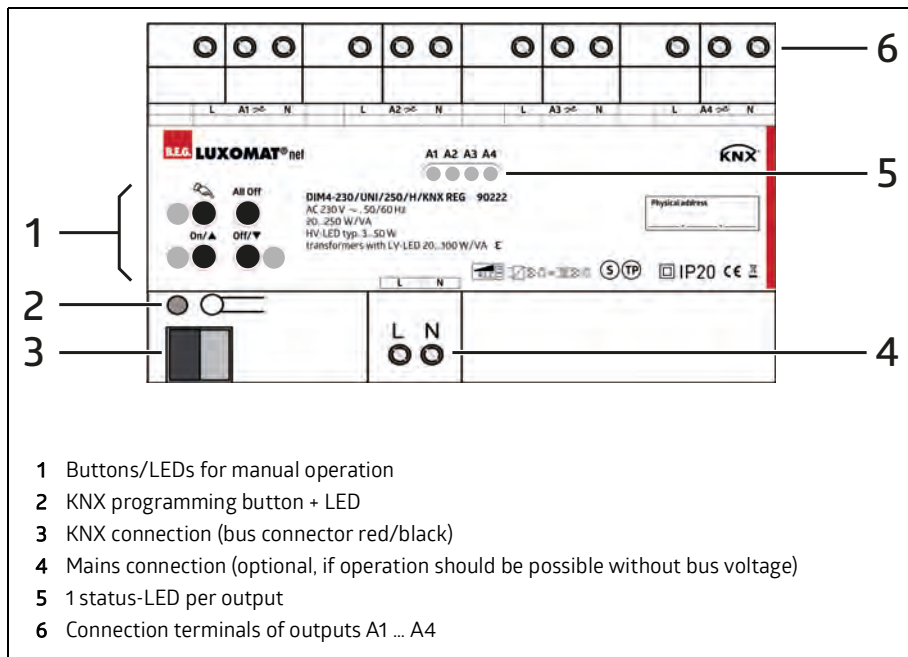

3.2 Function

3.2.1 System information

This device is a product of the KNX system and complies with the KNX directives. Detailed technical knowledge obtained in KNX training courses is a prerequisite to proper understanding.

The function of this device depends upon the software. Detailed information on loadable software and attainable functionality as well as the software itself can be obtained from the manufacturer's product database. Planning, installation and commissioning of the device are carried out with the aid of KNX-certified software. The latest versions of product database and the technical descriptions are available on our website.

3.2.2 Product characteristics

- Automatic or manual selection of the dimming principle suitable for the load
- Protected against no-load, short-circuit and overheating
- Signal in the event of a short-circuit
- Outputs can be operated manually
- Feedback of the switching position and the dimming value
- Parameterisable switch-on and dimming behaviour
- Increase in output power possible through parallel switching of multiple outputs
- Time functions: switch-on delay, switch-off delay, staircase lighting timer with run-on time
- Light scene operation
- Disabling of individual outputs manually or via bus
- Status indication of the outputs via LED
- Operating hours counter
- Mains failure longer than approx. 5 seconds leads to switch-off of the dimmer actuator. Depending on the parameter setting, the connected load is calibrated after resumption of power supply.

NOTICE

Delivery state: Construction site mode, outputs can be operated using button field.

Flickering of the connected lamps due to undershoot of the specified minimum load or through centralised pulses from the power stations is possible. This does not represent any defect in the device.

Power extension possible by means of our own power boosters.

→ Do not connect any LED lamps or compact fluorescent lamps in combination with power boosters.

4 Operation

4.1 Operating elements

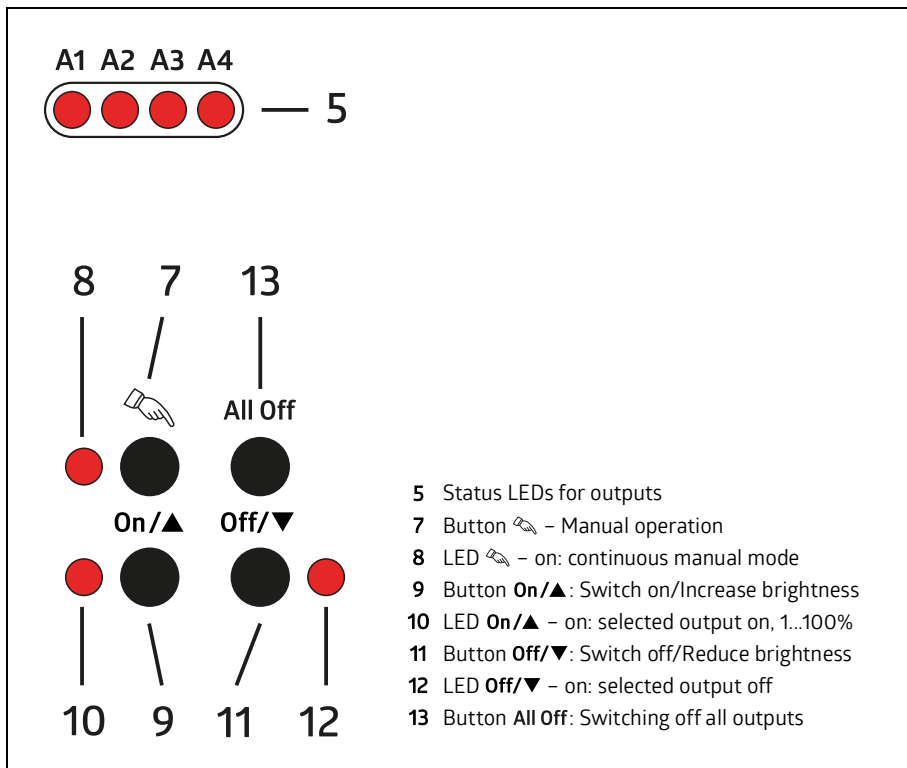

4.2 Status indication

The status LEDs **A1 ... A4** indicate the states of the outputs.

- **Off**: output switched off
- **On**: output switched on
- **Flashes slowly**: output in manual mode
- **Flashes quickly**: output disabled via continuous manual mode

4.3 Operating modes

Bus operation:

Operation via push-button sensors or other bus devices

Short-term manual operation:

Manual operation locally with button field, automatic return to bus operation.

Continuous manual mode:

Exclusively manual operation on the device

NOTICE



- No bus operation is possible in manual mode.
- Manual mode is possible in case of bus failure.
- After a bus failure and restoration the device switches to bus operation.
- After a power failure and restoration the device switches to bus operation.
- The manual mode can be disabled in ongoing operation via a bus telegram.

4.4 Manual mode

NOTICE



Manual mode

Manual operation is only possible when the bus or mains voltage supply of the actuator is switched on. Manual operation is terminated in the event of bus and mains voltage failure.

4.4.1 Switching on the temporary manual mode

Operation using the button field is programmed and not disabled.

→ Press the  button briefly.

LED **A1** flashes, LED  remains off.

After 5 seconds without a button-press, the actuator returns automatically to bus operation.

4.4.2 Switching off temporary manual mode

The device is in short-term manual mode.

→ No button-press for 5 seconds.

or

→ Press  button briefly as many times as necessary until the actuator leaves the short-time manual mode.

LEDs **A1 ... A4** no longer flash, but rather indicate the output status.

4.4.3 Switching on permanent manual mode

Operation using the button field is programmed and not disabled.

→ Press the  button for at least 5 seconds.

LED  is illuminated, status LED **A1** flashes, permanent manual mode is switched on.

4.4.4 Switching off permanent manual mode

The device is in permanent manual mode.

→ Press the  button for at least 5 seconds.

LED  is off, bus operation is switched on.

4.5 Operating the outputs

The device is in permanent or short-term manual mode.

→ Press  button briefly as many times as necessary until the desired output is selected.

The LED of the selected output **A1 ... A4** flashes.

The LEDs **On/▲** and **Off/▼** indicate the status.

→ Operate output with **On/▲** or **Off/▼** button.

- **Short:** switch on/off.
- **Long:** dim brighter/darker.
- **Release:** Stop dimming.

The LEDs **On/▲** and **Off/▼** indicate the status.

NOTICE



Short-term manual operation

After running through all of the outputs the device exits manual mode after another brief press.

4.5.1 Switching off all outputs

The device is in permanent manual mode.

→ Press the **All Off** button.

All outputs are shut off.

4.5.2 Disabling individual outputs

The device is in permanent manual mode.

→ Press  button briefly as many times as necessary until the desired output is selected.

The status LED of the selected output **A1 ... A4** flashes.

→ Press **On/▲** and **Off/▼** buttons **simultaneously** for at least 5 seconds.

Selected output is disabled.

The status LED of the selected output **A1 ... A4** flashes quickly.

→ Activate bus mode (see chapter 4.4.4 "Switching off permanent manual mode").

NOTICE



Disabled output

A disabled output can be operated in manual mode.

When a disabled output is selected in manual mode, the corresponding status LED flashes twice briefly at intervals.

4.5.3 Re-enabling outputs

The device is in permanent manual mode.

→ Press  button briefly as many times as necessary until the desired output is selected.

The status LED of the selected output **A1 ... A4** flashes twice briefly at time intervals.

→ Press **On/▲** and **Off/▼** buttons **simultaneously** for at least 5 seconds.

Selected output is enabled.

LED of the selected output flashes slowly.

→ Activate bus mode (see section Switching off permanent manual mode).

5 Mounting

⚠ DANGER	
	<p>Electrical shock when live parts are touched. Electrical shocks can be fatal.</p> <p>→ Before working on the device, disconnect the power supply and cover up live parts in the working environment.</p> <p>This device is not to be used to isolate other equipment from the mains supply.</p>

5.1 Mounting the device

- Observe the temperature range.
- Ensure adequate cooling.
- Maintain a distance of 18 mm (1 rail unit) when operating multiple dimmers or power units within the same control cabinet.
- Mount device on DIN rail. Output terminals must be at the top.

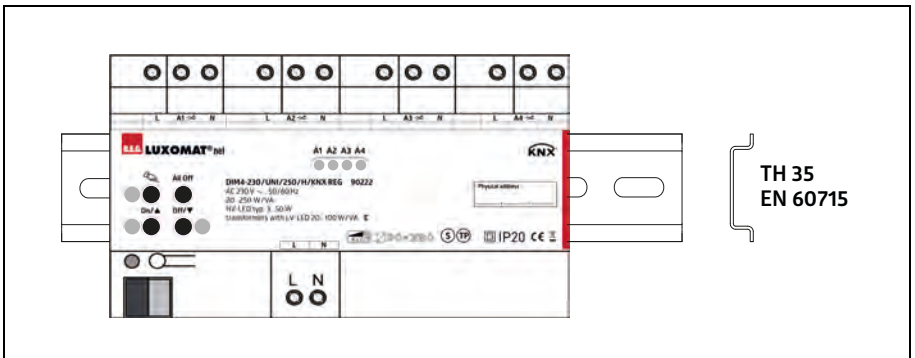

⚠ CAUTION	
	<p>Observe KNX installation regulations!</p> <p>This device complies with the KNX guidelines. Detailed knowledge of the KNX system is required for commissioning.</p>

5.2 Cover for KNX bus connector

It is necessary to install a cover to protect the bus connection against hazardous voltages in the connection area.

Installing the cover

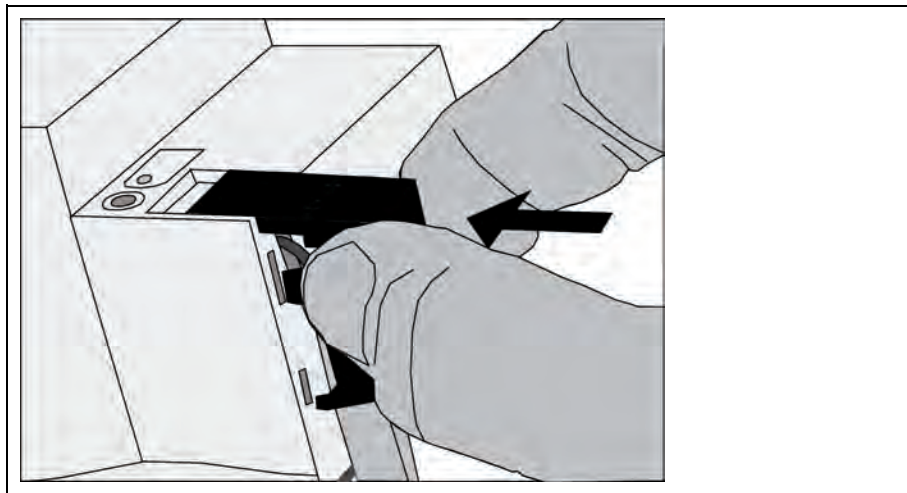

→ Route the bus line towards the rear.



→ Install cover on top of the bus terminal so that it snaps into place.

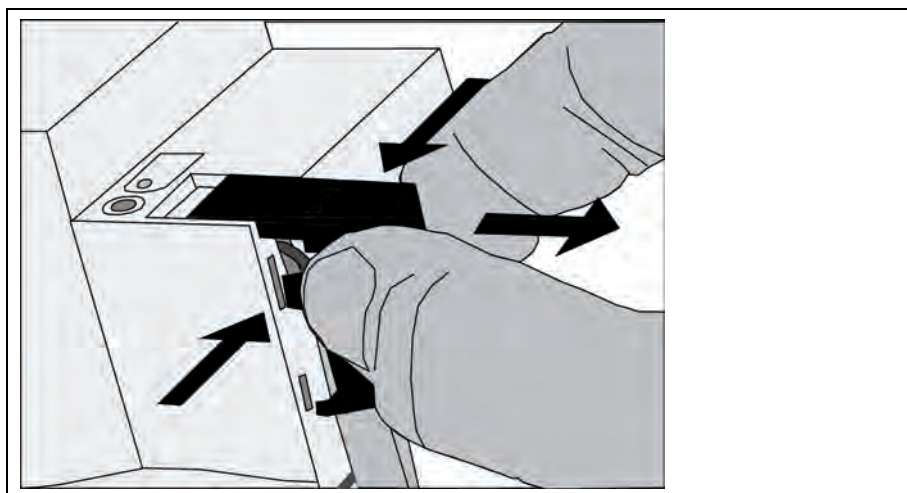

Removing the cover



→ Press the cover to the side and pull it off.

6 Electrical connection

 DANGER	
	Electrical shock when live parts are touched.
	Electrical shocks can be fatal. → Before working on the device, disconnect the power supply and cover up live parts in the working environment.
	This device is not to be used to isolate other equipment from the mains supply.

 CAUTION	
	Observe KNX installation regulations!
	This device complies with the KNX guidelines. Detailed knowledge of the KNX system is required for commissioning.



The device has a mains voltage connection that is independent of the load outputs for supplying the device electronics of the manual operation and integrated bus coupling unit.

The mains connection is required for construction site operation (manual operation without a connected bus voltage).

The device electronics and bus coupling unit are also supplied from the bus coupling unit so that an ETS programming operation or manual operation is also possible even if the mains voltage is not connected or is switched off. As long as the bus voltage is connected and ready for operation, the device's internal power supply is switched off to save energy.

The load outputs have separate mains voltage connections for supplying the digital dimmer packs and the connected load.

6.1 Clampable conductor cross-sections

	0.5 ... 4.0 mm ²
	0.5 ... 4.0 mm ²
	0.5 ... 2.5 mm ²

6.2 Standard connection

⚠ CAUTION

Danger of destruction from mixed loads!



The dimmer and load may be destroyed.

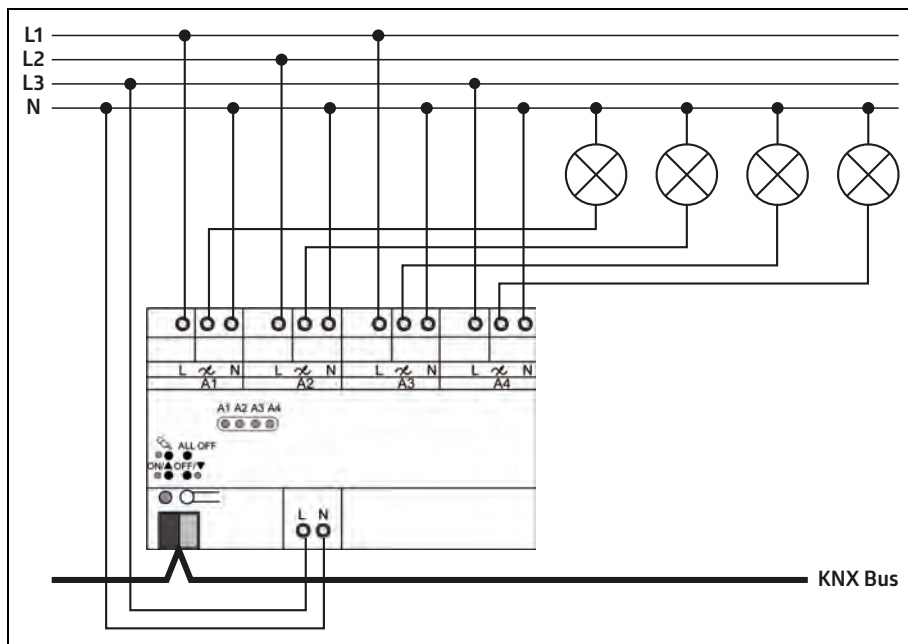

- Do not connect capacitive loads, e.g. electronic transformers, and inductive loads, e.g. inductive transformers, together on the same dimmer output.
- Do not connect inductive transformers together with HV LED lamps or compact fluorescent lamps on the same dimmer output.





→ Connect device as shown in the wiring diagram above.

 CAUTION	
	<p>Connected load!</p> <ul style="list-style-type: none">→ Do not exceed permissible total load including transformer power dissipation.→ Operate inductive transformers with at least 85% nominal load.→ Mixed loads with inductive transformers: ohmic load max. 50%. <p>HV-LED lamps and compact fluorescent lamps:</p> <ul style="list-style-type: none">→ Only connect lamps of one manufacturer and of the same type on the same output.→ Do not connect any other loads to this output.→ Connect 600 W HV LED lamps or compact fluorescent lamps at most per 16 A circuit breaker. <p>The dimming principle in the as-delivered state: "Universal"</p> <p>If setting the dimming principle manually, ensure that the dimming principle and the connected load match. Observe the information in the Technical Documentation.</p> <p>Only use the settings "HV LED phase cut-off" and "HV LED phase cut-on" for HV LED lamps or compact fluorescent lamps.</p>

Changing connected load type

When changing the connected load, e. g. replacement of a connected luminaire, the dimmer actuator only calibrates itself again after disconnection of the mains voltage and load.

 CAUTION	
	<p>Risk of destruction if the preset dimming principle and connected load do not match.</p> <p>The dimmer and load may be destroyed.</p> <ul style="list-style-type: none">→ Before changing the dimming principle, observe connected load type.→ Before changing the load type, make sure that the dimming principle is correct.

- Disconnect load circuit.
- Disconnect mains voltage.
- Connect changed load.
- Program dimmer actuator to the new load type.

6.3 Parallel connection of outputs – connecting lamp load up to 950 W

Several dimmer outputs can be combined for dimming greater loads.

⚠ CAUTION

Danger of destruction!

400 V are shorted when outputs switched in parallel are connected to different outer conductors.

The device will be destroyed.

- Always connect outputs switched in parallel to the same outer conductor.
- Do not connect any LED lamps or compact fluorescent lamps to dimmer outputs switched in parallel.
- Only utilize parallel-switched outputs up to 95 % each.
- Do not expand parallel-switched dimmer outputs with universal power packs.

Observe delivery state!

- Before connecting and switching on, program the dimmer actuator to the changed output configuration.

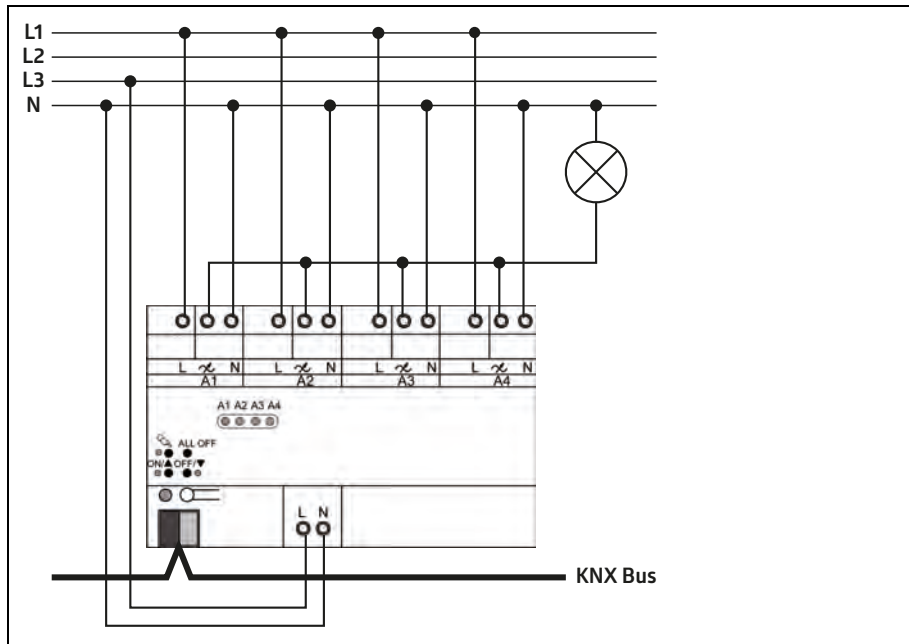

→ Connect device as shown in the wiring diagram (example) above.

6.4 Installing power boosters

Choose power boosters that are suitable for the dimmer and load. Program the operation together with universal power boosters in the device. For more information please see instructions of the respective power pack.

Preferably use **B.E.G. Universal Power Booster LZ-230/UNI/420 REG** (Article No. **90223**).

7 Commissioning

CAUTION



Risk of destruction if the preset dimming principle and connected load do not match.

The dimmer and load may be destroyed.

→ Before commissioning, make sure that the software setting matches the load.

7.1 KNX programming mode

Loading physical (individual) address and product database

- Switch on the bus voltage.
- Press the programming button.
- Load the physical (individual) address into the device.
- Load the product database.
- Switch on voltage supply on the outputs.
- Switch mains voltage on.

7.2 Commissioning via ETS

7.2.1 ETS product database

The ETS database (for ETS 4.2 and ETS 5) and the application description can be downloaded from the product website of the DIM4-230/UNI/250/H/KNX REG dimming actuator:



<https://beg-luxomat.com/qr.php?prtno=90222>

NOTICE



Application description

A detailed description of the device parameterisation can be found in the application description of the dimming actuator.

7.3 Calibration procedure

After switching on the mains voltage, the device calibrates itself to the load and selects the appropriate dimming procedure phase cut-on or phase cut-off.

NOTICE

Calibration procedure

The calibration procedure becomes noticeable during ohmic loads by a brief flicker and lasts between 1 to 10 seconds depending on the network conditions.



During the calibration phase, received operations are executed after completion of the calibration procedure.

The dimming procedure can also be predefined with the parameterization. In this case, the calibration procedure is not necessary.

8 Care, maintenance and disposal

8.1 Cleaning

If necessary, clean the device surface with a soft, lint-free cloth.

NOTICE

Do not use aggressive cleaning agents!



→ Do not use aggressive cleaning agents such as thinner or acetone for cleaning the device.

→ To clean the device, use only a lint-free cloth.

Tips and hard objects can destroy the device.

8.2 Maintenance

Usually, the device does not require any maintenance by the operator. Repairs to the device must only be carried out by the manufacturer.

For repairs, contact your local B.E.G. Brück Electronic subsidiary or directly B.E.G. Brück Electronic GmbH, Germany.

8.3 Disposing

For disposal observe the applicable national regulations regarding electronic components.

9 Diagnostics and troubleshooting

9.1 Troubleshooting

Problem	Possible cause	Remedy
Connected LED lamps or compact fluorescent lamps switch off in the lowest dimming position or flicker	The set minimum brightness is too low.	→ Increase minimum brightness.
Connected LED lamps or compact fluorescent lamps flicker	Lamps are not dimmable.	→ Check manufacturer's instructions. → Exchange lamps for another type.
	Dimming principle and lamps do not optimally match.	→ For HV-LED: Check operation in another dimming principle, reduce connected load as well if necessary. → For LV-LED: Check the lamp operating device and replace as necessary. → With the "Universal" setting: Define the dimming principle manually.
Connected HV-LED lamps or compact fluorescent lamps in the lowest dimming position are too bright; dimming range is too small	The set minimum brightness is too high.	→ Reduce minimum brightness.
	HV-LED phase cut-off dimming principle does not optimally match the connected lamps.	→ Check operation in the "HV-LED phase cut-on" setting, reduce connected load as well if necessary. → Exchange lamps for another type.
Output has switched off	overheating protection has tripped.	→ Disconnect mains supply and all outputs from the mains, switch-off corresponding circuit breakers. → HV-LED phase cut-off: Reduce the connected load. Exchange lamps for another type. → HV-LED phase cut-on: Reduce the connected load. Check operation in the "HV-LED phase cut-off" setting. Exchange lamps for another type. → Let device cool down for at least 15 minutes. → Check installation situation → Ensure cooling, e.g. provide distance from surrounding devices.

Problem	Possible cause	Remedy
Output has switched off	Surge protection has triggered.	<ul style="list-style-type: none"> → HV-LED phase cut-off: Check operation in the "HV-LED phase cut-on" setting, reduce connected load as well if necessary. → Exchange lamps for another type.
	Short-circuit in output circuit	<ul style="list-style-type: none"> → Disconnect mains voltage and affected output from the mains supply. → Eliminate short-circuit. → First switch on the output voltage again and then the mains supply. → Switch the affected output off and on again.
	Load failure	<ul style="list-style-type: none"> → Check load → Replace light bulb → For inductive transformers, check primary fuse and replace if necessary.
Manual control with button field not possible	Manual control has not been programmed.	→ Program manual control.
	Manual control via bus disabled.	→ Enable manual control.
Output cannot be operated	Manual control has not been programmed.	→ Reprogram device.
	Manual control via bus disabled.	→ Enable manual control.
None of the outputs can be operated.	All of the outputs are disabled.	→ Cancel disabling.
	Manual mode active.	→ Deactivate manual mode (switch off permanent manual mode).
	Application software missing or faulty.	→ Check programming and correct.
	Application software has been stopped, programming LED is flashing.	→ Disconnect device from the bus and mains, switch on again after 10 s.
All outputs off and not possible to switch on	Bus voltage failure.	→ Check bus voltage.
	Mains voltage failure.	→ Check mains voltage on outputs and mains power supply.

Problem	Possible cause	Remedy
Luminaires flicker or buzz, proper dimming not possible, device buzzes.	Wrong dimming principle set. Installation or commissioning error.	<ul style="list-style-type: none"> → Disconnect device and luminaire, switch off circuit breaker. → Check installation and correct. → If the wrong dimming principle has been pre-selected: Set correct dimming principle. → If dimmer actuator calibrates itself incorrectly, e.g. with highly inductive mains or long load cables: Preselect correct dimming principle with commissioning.

NOTICE

Overvoltage / short-circuit!



- The response of the surge protection can be signalled by sending a short-circuit telegram or can be determined by polling the "short-circuit" communication object.
- When a short-circuit occurs the affected output switches off. Automatic restart when short-circuit is eliminated within 100 ms (inductive load) or 7 seconds (capacitive or ohmic load). After that lasting switch-off.
- When a short-circuit occurs during the calibration process, the load calibrates itself again after the short-circuit is eliminated.

9.2 Diagnosis via the ETS

NOTICE

Diagnosis / Troubleshooting via the ETS!



- Use the corresponding ETS functions for diagnosis / troubleshooting, e.g.
 - Group Monitor
 - Bus Monitor
 - Line Scan

10 Service and support

10.1 Manufacturer's warranty

The company B.E.G. Brück Electronic GmbH grants a warranty in accordance with the warranty conditions, which you can download from the website at <https://www.beg-luxomat.com/service/downloads/>.

10.1.1 Product code

The product is provided with a product code that enables the product to be traced in the event of a warranty/complaint.

The product code of the **DIM4-230/UNI/250/H/KNX REG** is labelled on the back of the housing.

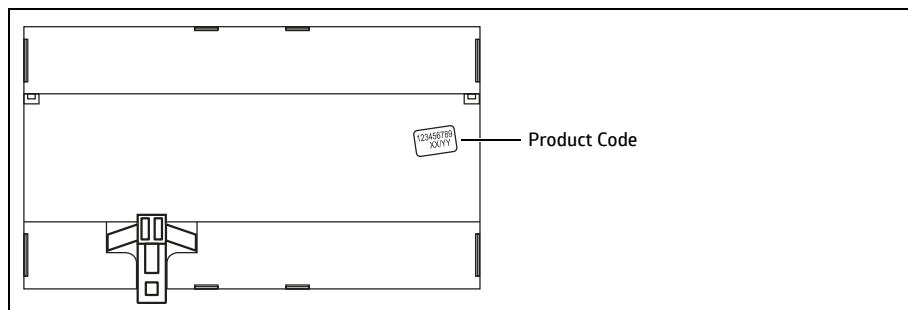

10.2 Contact details

Service hotline:

+49 (0)2266 90121-0

Monday to Thursday 8.00 to 16.00 (UTC+1) Friday 8.00 to 15.00 (UTC+1)

E-mail:

support@beg.de

Return address for repairs:

Contact your B.E.G. subsidiary or representative.

The contact details can be found at <https://www.beg-luxomat.com/en-in/service/service-points/>.

Or contact us directly at

B.E.G. Brück Electronic GmbH

Gerberstrasse 33

51789 Lindlar

GERMANY

11 Technical Data

11.1 General data

Rated voltage	AC 230 V~
Mains frequency	50/60 Hz
Power loss	max. 8 W
Standby power	max. 1.4 W
Contact type	£, MOSFET
Power consumption 230V~ per output	
incandescent lamps	20 ... 250 W
HV halogen lamps	20 ... 250 W
HV LED lamps	typ. 3 ... 50 W
Compact fluorescent lamps	typ. 3 ... 50 W
Inductive transformers	20 ... 250 VA
Inductive transformers with LV LED	20 ... 100 VA
Electronic transformers	20 ... 250 W
Electronic transformers with LV LED	20 ... 100 W
Mixed load ohmic-inductive	20 ... 250 VA
Mixed load ohmic-capacitive	20 ... 250 W
KNX	
KNX rated voltage	DC 21 ... 32 V SELV
KNX connection	Bus connector red/black
KNX medium	TP256
KNX current consumption	15 mA
KNX commissioning mode	S-Mode
Housing	
Controls and indicators	4 buttons, 3 red LEDs (operation), 4 red status LEDs (outputs A1 ... A4) KNX programming button with LED (red)
Housing	DIN rail-mounted device
Housing material	PC / POM
Housing width	144 mm (8 rail units)
Weight	approx. 220 g
Ambient data	
Protection class / degree of protection	II / IP20
Ambient temperature (operating/storage)	-5 °C - +45 °C / -25 °C - +70 °C

<p>Conformity with standards</p>	<p>Low-voltage directive 2014/35/EU EN 50491-3:2009 EN 50491-4-1:2012 EN 50428:2005 EN 50428:2005/A1:2007 EN 50428:2005/A2:2009 EMC Directive 2014/30/EU EN 50491-5-1: 2010 EN 50491-5-2: 2010 EN 50428:2005 EN 50428:2005/A1:2007 EN 50428:2005/A2:2009 RoHS Directive 2011/65/EU EN 50581:2012 ErP Directive 2009/125/EC</p>
<p>Nameplate</p>	

11.2 Dimensioned drawing DIM4-230/UNI/250/H/KNX REG

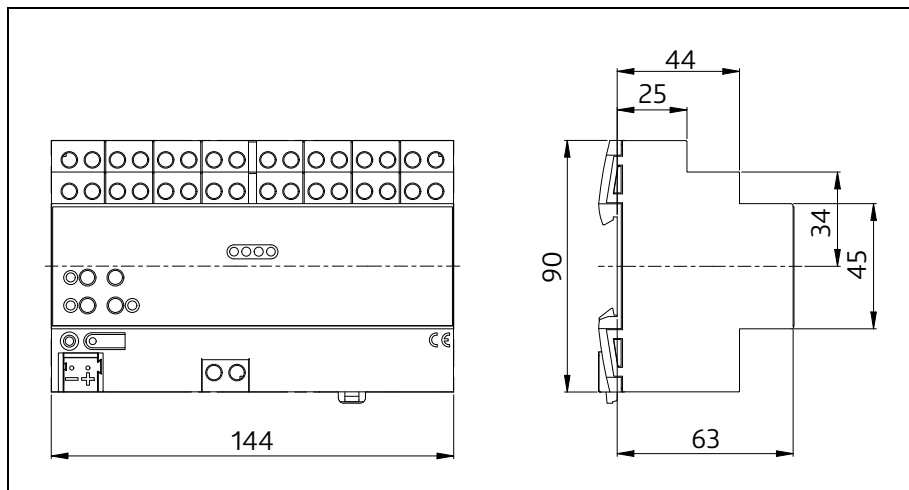

12 EU declaration of conformity

The product complies with the following EU directives

1. Electromagnetic Compatibility (2014/30/EU)
2. Low voltage (2014/35/EU)
3. Restriction of the use of certain hazardous substances in electrical and electronic equipment (2011/65/EU)
4. Ecodesign requirements for energy-related products (2009/125/EC)

NOTICE



EU declaration of conformity

A detailed EU declaration of Conformity can be found at www.beg-luxomat.com or can be requested from the manufacturer.



Brück Electronic GmbH
Gerberstraße 33
51789 Lindlar
GERMANY

T +49 (0)2266-90121-0
F +49 (0)2266-90121-50

info@beg.de
beg-luxomat.com