

# B.E.G. LUXOMAT® PD4-M-DIM-HVAC

## Installation and Operating Instruction for B.E.G.-Occupancy detectors PD4-M-DIM-HVAC-FC

### 1. Mounting preparations

Work on the 230 V mains supply may only be carried out by qualified professionals or by instructed persons under the direction and supervision of qualified skilled electrical personnel in accordance with electrical regulations.

Disconnect supply before installing!  
The device is not suited for safe disconnection of the mains supply.

When in Master/Slave mode of operation, the Master-appliance must always be installed at the location where there is least daylight.

### 2. Installation of the LUXOMAT® PD4-M-DIM-HVAC-FC

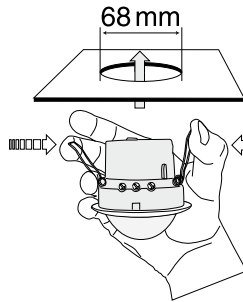

A circular opening of diameter 68 mm must first of all be produced in the ceiling.

Having connected up the cables in accordance with regulations, the detector is inserted into the opening as shown in the drawing opposite and fixed into position with the assistance of the spring clip.

### 3. Position DIP-switches

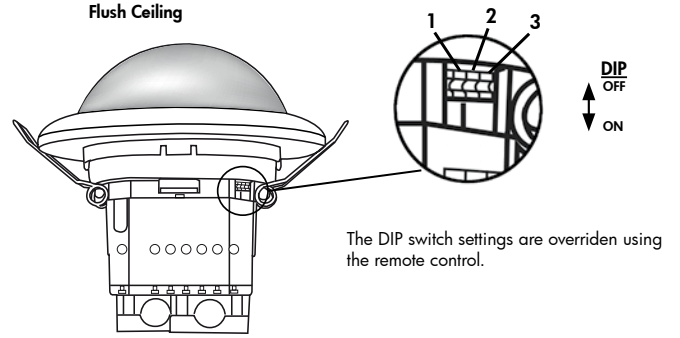

The DIP switch settings are overridden using the remote control.

### 4. DIP switch functions

DIP-switch	ON	OFF
1	Semi automatic mode	Fully automatic mode
2	LED OFF	LED ON
3	Corridor mode	Standard mode

The DIP settings are enabled again by

- Adjusting the DIP switches when closed
- Reset with test sun setting at the potentiometers
- Reset when open

**Function LEDs OFF:** In the open state and in test mode, the LEDs are always ON.

**Corridor function:** After deactivation by an external push button, the detector switches off and returns to automatic mode after 5 sec.

### 5. Putting into operation / Settings

**Self test cycle**  
After an initial 60-second self-test cycle, the LUXOMAT® PD4-M-DIM-HVAC is ready for operation.

**Follow-up time for light control**  
The time can be set infinitely variably at between 1 and 30 minutes.  
Symbol **TEST**: Test mode  
Every movement switches on the light for a period of 1 second, switching it off for a period of 2 seconds after that regardless of the level of brightness

**Twilight-switch for light control (relay 1)**  
The switch-on value for the light can be set at between 10 and 2000 Lux. Using the rotary control, the luminance set points can be set as desired.  
Symbol ☾: Night-time operation  
Symbol ☀: Daytime/Night-time operation

**Orientation lighting**  
This rotary controller serves to determine the working time of the orientation lighting (fixed to 20 %).  
"ON" for permanent orientation lighting.  
"OFF" for deactivation of orientation lighting.

**Follow-up time for appliance-control**  
The time can be set infinitely variably at between 5 minutes and 120 minutes. After 15 minutes the switch-on delay is activated. This is around 5min. If there are not detected any further movements within this period, the switch-on delay starts again.  
Symbol  $\square$ : Impulse = 2.5 sec.  
Symbol **A**: Alarm impulse = 2 sec.

**Alarm impulse**  
In order to set off an alarm impulse, at least 3 movements within 9sec. have to be detected.  
**Pulse spacing PD-Slave**  
2 or 9 seconds can be set for the pause between 2 pulses sent to the master. The setting can be made with activated (☀) or deactivated (☾) LED indicator.  
For devices with a separate slave input, 2 sec. can be set.

### 6. Settings carried out using remote control (optional)



**1. Check Battery:**  
Open battery compartment by pressing the plastic springs together and removing the battery-holder.

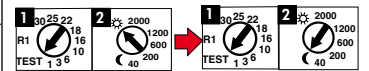

**2. IMPORTANT**  
Please pay attention, that the setting is Potentiometer 1 at "TEST" and Potentiometer 2 not at "SUN". All values which have been programmed using the remote control will be deleted in the event of power failure in the position "TEST/SUN". Please switch Potentiometer 2 over to "MOON" or any other value.

**Caution:**  
Settings with remote control supersede the settings by courtesy of potentiometers.

### 7. Option:

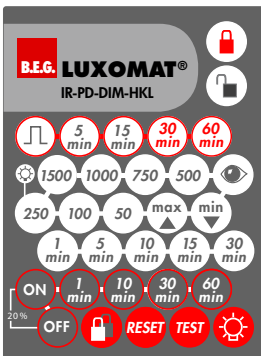

IR-PD-DIM-HKL



Wall bracket for remote control IR-PD-DIM-HKL

### 8. Settings by remote control

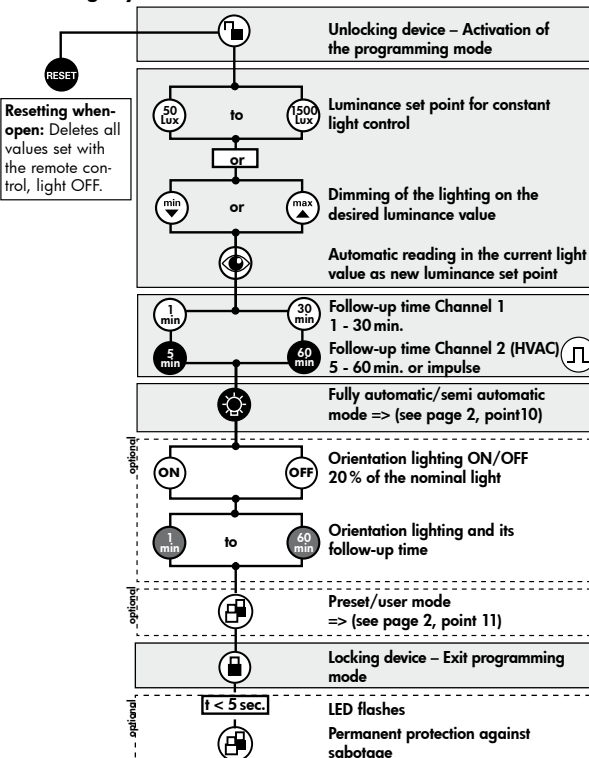

### 9. Explanation of the remote control button functions

- In the initialization period**  
During initialization phase/self test cycle Lights can be set to on or off status during initialization(60 Seconds) by using INI OFF/ON mode.  
**Light on / off when closed**  
=> (see page 2, point 12)
- Dimming in the closed state**  
=> (see page 2, point 11)
- Test operation in the closed condition to enable**  
Disable the test mode: press reset
- Resetting when closed**  
The lighting relay is switched off, i.e. opened and the follow-up times reset.
- Permanent protection against sabotage**  
This function blocks the unit permanently (green LED is illuminated). This operating mode can only be activated during the period of 5 seconds after pressing the "lock" button. This status will only permit actuating the function "Light on/Light off". The procedure for leaving this mode is as follows:
  1. Switch off the current
  2. Apply current for 31 - 59 seconds
  3. Switch of the current again
  4. Apply current
  5. Open detector
- Dim in the open state**  
To set a target value, proceed as follows (example workplace): Place one lux meter flat on the desk. Set the light. With the help of remote control IR-PD4-DIM by pressing the buttons „max“ or „min“ as necessary. Wait until the desired light level is reached.
- Confirmation by the preset value**  
**Light during the initialization**  
The light is on by default in the initialization time. On / off with the „Light“ button during Initialization. The final condition is then active.
- Orientation light ON / OFF when open**  
Note: Also during the orientation phase of the light constant light control is active: With sufficient brightness is <20% dimmed and turned off the lights if necessary.

## 10. Fully / Semi automatic mode

(for IR-PD-DIM-HKLfunctions see page 1)



The system switches over when the "Light" push-button is open (see remote control functions, page 1).

Each time a push-button is pressed, the current operating mode is indicated by the red LED:

Lit for 3 sec. = Fully automatic mode

Flashes for 3 sec. = Semi-automatic mode

### Fully automatic operation

In this operating mode, the lighting switches automatically on and off for increased comfort, depending on presence and brightness.

### Semiautomatic operation

**(Semiautomatic can only be activated via the remote control!)**

In this operating condition, in order to gain increased savings, the lighting is energized only after being manually switched on. Switch-off takes place automatically. The semiautomatic mode basically behaves like the fully automatic. However, the difference is that switching-on must always be carried out manually!

As many (closer-contact) buttons as desired can be wired in parallel on the "S" button input (ON/OFF Dimm).

## 11. Manual Dimming – Preset /User

(for IR-PD-DIM-HKLfunctions see page 1)



You can dim manually by pressing the push button for a long time (> 2 sec). When the button is released, the current dimming value is retained. Upon renewed dimming, the dimming direction is reversed.

**PRESET** – the luminance set point is set during start-up operation by the installer and remains unchanged. The luminance set-point configured through manual dimming is only applied for the time being.

### Caution:

The constant light regulation is now deactivated! The currently set artificial light is retained independent of the ambient/daylight brightness! After switching off and then back on, the originally set luminance set-point is reset = constant light regulation is activated.

### USER – can only be activated via the remote control!

The luminance set-point is changed upon each manual dimming and re-adjusted by the user (Conformation through relay clicking!) The constant light regulation remains activated!

## 12. Manual Switching



The light will remain switched on or off, as movements are detected in the area. After the last detected movement the light will be off for the duration of the set-up time. The device will then return independently to the Operation mode (Full or Semi-automatic).

## 13. Range

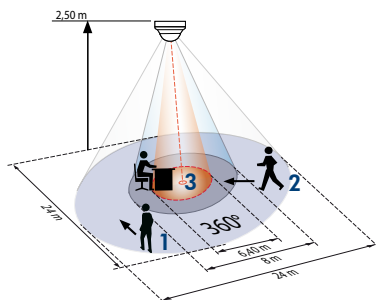

- 1 ■ Walking across
- 2 ■ Walking towards
- 3 ■ Seated

## 14. Wiring diagrams

### Standard mode with master-DIM-HVAC-occupancy detectors

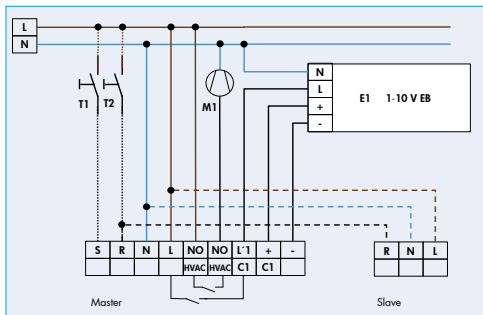

M1 = HVAC-Function

### optional

T1 = NO Taster for Light-Channel

T2 = NO Taster for HVAC-Channel

Slave to the extension of coverage

## 15. Connections

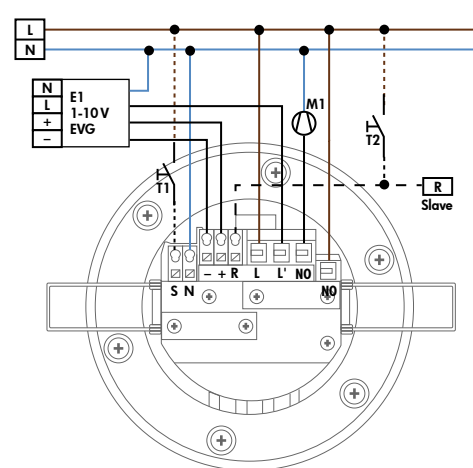

PD4-M-DIM-HVAC-FC

## 16. Manual switching HVAC-Channel

### 230VAC for 0.1 - 1 second on the slave port R

Lay on the slave port R for 0.1 - 1 second to 230VAC, is this like a key signal for the HVAC channel interpreted.

## 17. Article / Part nr. / Accessory

Type	SM	FC	FM
PD4-M-DIM-HVAC (Master)	-	92507	-
PD4-S (Slave)	92142	92254	92163

### LUXOMAT® Remote control

IR-PD-DIM-HKL(incl. wall bracket) 92114

### Accessory:

BSK Ball basket guard 92199

Occupancy detectors – Covering IP23 92206

## 18. Exclude sources of interference

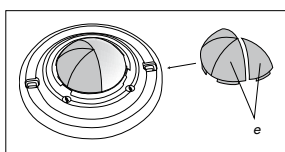

In case the sensing area of the LUXOMAT® PD4-M-DIM-HVAC is too large or areas are being covered that should not be monitored, the range can be reduced or limited through use of the enclosed masking clips

## 19. Technical data PD4-M-DIM-HVAC

Sensor and power supply in one case for onwall-, ceiling- and flushmounting

**Power supply:** 230V~ ±10%

**Power consumption:** < 1W

**Ambient temperature:** -25°C to +50°C

**Degree of protection/class:** FC IP20 / II

**Settings:** locally and by remote control

**Light values remote control:** 50 - 1500 Lux

**Extension of the detection area:** with Slaves

**Area of coverage:** circular 360°

**Range of coverage Ø H 2,50 m / T = 18°C:**  
seated 6,40m / tangential 24 m / radial 8 m

**Recommended height for mounting:** 2 - 3 m

**Light measurement:** Mixed light, daylight + artificial light

**Lux values potentiometers:** 10 - 2000 Lux

### • Channel 1 for light-connection

**Type of contact:** NOC/with pretravel tungsten contact

**Contact load:** 2300W cos φ=1 /

1150 VA cos φ=0,5, μ-Contact

1 x (1-10V)

**DIM-Outputs:**  
**Max. no. of series-connected electronic ballasts:** max. 50 electronic ballasts by one single supply with max. 100m cable run and a conductor cross-section of 0.75 mm²

**Time-settings:** 1 - 30 Min. / Test

### • Channel 2 for control devices (only reacts on motion)

**Contact load:** 230V~, 3A cos φ=1, μ-Contact

**Time-settings:** 5 min. - 120 min. with time delay of

5 min. for follow-up time > 15 min./

Alarm impulse

**Dimensions H x Ø [mm]** 103 x 98

**Visible portion when built into ceiling:** 38 x 98 mm

## Technical data PD4-Slave

**Power supply:** 230V~ ±10%

**Impulse output:** Optocoupler max. 2W

**Impulse duration:** 2s or 9s

**Dimensions:** see above

**Declaration of Conformity:** The product complies with the low voltage recommendation 2006/95/EC and the EMV recommendation 2004/108/EC.

**WE RECOMMEND THAT BEFORE DIMMING OF THE CONNECTED LIGHTS A 100H BURN IN (75 TUBES OR 80 HOURS FOR T8 TUBES) FUNCTION TA KES PLACE .**  
**THE LIFESPAN OF THE LAMPS CAN BE REDUCED IF THE BURN IN DOES NOT TA KE PLACE .**

## 20. LED-functional indicators, fault-finding

The functional indicators in the case of the LUXOMAT® PD4-M-DIM-HVAC (red and green LED's)

**Red LED indicating self-checking mode (over a period of 60 seconds following mains-supply lock-on)**

Flashing at intervals of 1 second

EEPROM/memory empty

Flashing rapidly

EEPROM/memory contains information

### Red LED as an indicator of status

Flashing irregularly

Movements are detected within the area of coverage

Flashing regularly

Detector identifies bright, light off

(dependent upon operating mode)

Not illuminated

Detector identifies dark, light on

(dependent upon operating mode)

Flashing extremely rapidly

Too bright / Too dark / Undefined

### Red LED as an acknowledgement of receipt for commands from the remote control

Illuminated for 2 seconds

Signal validly received

Illuminated for 0,5 seconds

Not-accepted command, detector blocked

Flashing extremely rapidly

Not-accepted command, occurs, for example, when an attempt is made to input twilight-value are too bright or too dark

### Green LED as an acknowledgement of receipt for commands from the remote control

Lights up for 3 seconds

Semi automatic or user signal correctly received

### Green LED as an indicator of status (only for status "Permanent protection against sabotage")

Flashing irregularly

Movement are detected within the area of coverage

Flashing regularly

Detector identifies bright, light off

(dependent upon operating mode)

Not illuminated

Detector identifies dark, light on

(dependent upon operating mode)

Illuminated for 2 seconds

Signal validly received

(dependent upon operating mode)

### White LED

Lights permanently

Semi-automatic active (shines)

Illuminates 4 seconds, then 1 sec off

Semi-automatic and active corridor

Illuminates 1 seconds, then 4 sec off

Only active corridor