

# B.E.G. LUXOMAT® PD4-M-3C-TRIO

## Installation and Operating Instruction for B.E.G. Occupancy detectors PD4-M-3C-TRIO-SM/-FC

### 1. Product information

- Occupancy detector designed especially for classrooms and training rooms
- Two channels for lighting groups
- One channel for blackboard lighting/HVAC
- One common detection area
- Two independent, movable light sensors
- Manual switching available with 3 switches
- Master version
- Extension of the detection area by slave devices is possible
- Other functions adjustable by remote control (optional)

### 2. Operation

The occupancy detector switches on the light automatically, depending on people being present (movements) and on ambient light. The light sensors integrated into the detector continually measure ambient light and compare it with the brightness thresholds set in the detector. If the ambient light is sufficient, lighting will not be switched. If the ambient light level is below the set value brightness, a movement activates the lighting in the room.

The detector switches the light off despite of a person being present if there is enough natural light for 15 min or if no movement is detected for one follow-up time.

### 3. Safety information

- Work on the mains supply may only be carried out by qualified professionals or by instructed persons under the direction and supervision of qualified skilled electrical personnel in accordance with electrotechnical regulations.
- Disconnect supply before installing!
- The device is not suited for safe disconnection of the mains supply.

### 4. Mounting

- In master/slave mode, the master device must always be installed at the location with least daylight.
- One of the light sensors should be pointed to the side away from the windows, and the other to the side near the windows.

#### 4a. Mounting SM

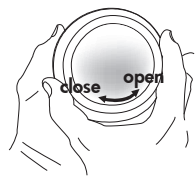

The detector must be installed on a solid and level surface.

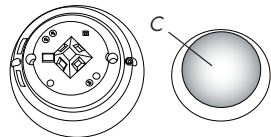

Before mounting, the lens must be removed. To remove it, the lens (C) must be turned about 5° anticlockwise and taken out.

Having connected up the wires in accordance with regulations, secure the detector with 2 screws. Then replace the lens by placing on the detector and turning clockwise. Connect mains voltage.

#### 4b. Mounting FC

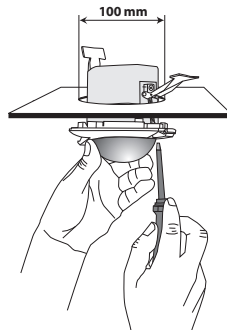

A circular opening of diameter 10 mm must be produced in the ceiling.

Having connected up the cables in accordance with regulations, the detector is inserted into the opening as shown and fixed into position with the retaining bracket using screws.

### 5. Position DIP switches, LEDs and Potentiometer

#### 5a. SM

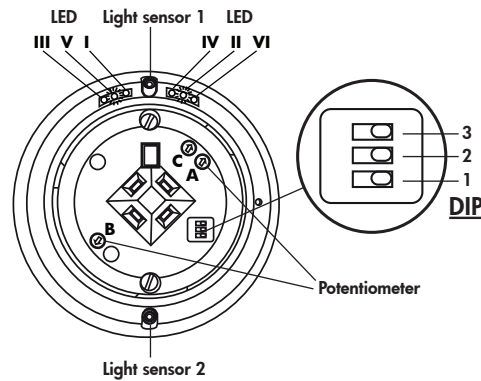

#### 5b. FC

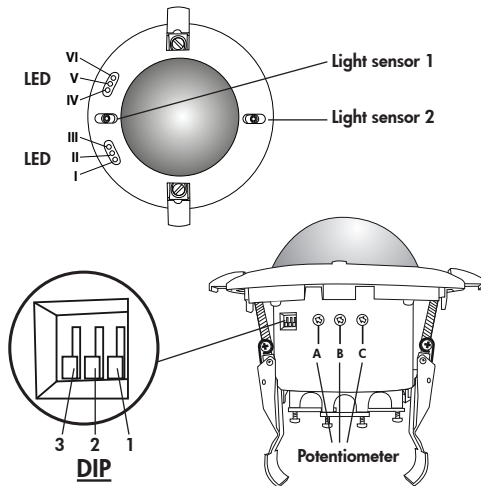

### 5c. Explanation

DIP switch functions		
DIP 1	Fully automatic channel 1, 2 and 3	Semi automatic channel 1, 2 and 3
DIP 2	INI ON	INI OFF
DIP 3		RESET

**Potentiometer A** Brightness threshold channel 1

**Potentiometer B** Follow-up time channel 1, 2, 3

**Potentiometer C** Brightness threshold channel 2

**LED I** red - INI ON/OFF

**LED II** green - too light/too dark light sensor 2

**LED III** white - semi-automatic switching channel 3

**LED IV** white - semi-automatic switching channel 1+2

**LED V** green - too light/too dark light sensor 1

**LED VI** red - motion indicator

### 6. Light measuring

In order to calculate a switching threshold, there is a five-minute light measurement. For this, the light is switched off by the detector for all channels for 5 seconds and then switched on for 5 minutes.

Measurement is carried out if:

- a threshold value for brightness is changed on a potentiometer
- a new threshold value is programmed by remote control (finish setting up with CLOSE switch)

The measurement is not done during the activated test function. Unlocking the device halts light measurement. After programming ends, light measurement is restarted.

### 7. Putting into operation / Settings

#### Self test cycle

After an initial 60-second self-test cycle (initialization), the LUXOMAT® PD4-M-3C-TRIO is ready for operation (LEDs blink).

#### INI OFF/ON mode:

There is a choice of having the light switched on or off during the self-test cycle. The factory setting is light on during self-test cycle (INI ON). If INI OFF is selected, the detector does not switch the light on after mains voltage is connected. Also, a movement only leads to switching on the light after 60 seconds.



**Brightness threshold channel 1 - potentiometer A**  
The brightness threshold can be set to between 10 lux (Moon symbol) and 2000 lux (Sun symbol). The brightness threshold can be set as required with the potentiometer.

Symbol ☾: Night operation  
Symbol ☀: Daytime operation (light evaluation inactive)



**Follow-up time channel 1, 2, 3 - potentiometer B**  
The time can be set infinitely variably at between 1 and 60 minutes. The time-setting is valid for all 3 channels of the PD4-M-3C-TRIO.

Symbol TEST: Test mode  
Every movement switches on the light for a period of 1 seconds, switching it off for a period of 2 seconds after that regardless of the level of brightness.

If channel 3 is set to "HVAC" and a follow-up time of greater than 15 minutes is selected, a switch-on delay is active. This means that when movement is detected, channel 3 is only switched on after 5 minutes.



**Brightness threshold channel 2 - potentiometer C**  
For explanation see potentiometer A.

### 8. Wiring diagram

#### Standard mode with Master 3-channel TRIO occupancy detectors

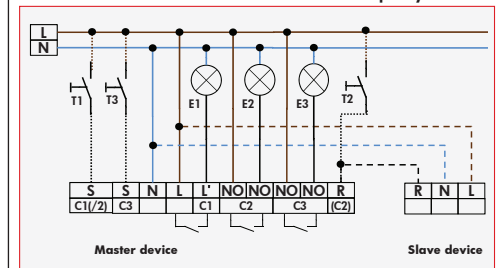

#### Optional

Slave devices for extension of detection area

As many NO switches as required can be switched in parallel on switch inputs S or R.

## 9. Range of Coverage

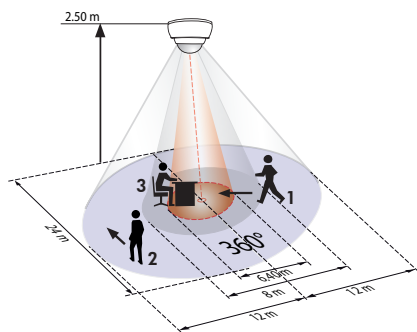

- 1 Walking towards
- 2 Walking across
- 3 Seated

## 10. Exclude sources of interference

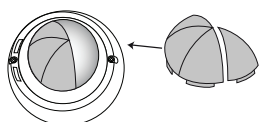

If the detection zone is too large, or areas are covered that should not be monitored, use the blinds to reduce or limit those areas.

## 11. Technical data

**Power supply:** 110-240 VAC, 50/60 Hz

**Power consumption:** < 1 W

**Ambient temperature:** -25°C to +50°C

**Degree of protection / class:** IP20 / II

**Settings:** Potentiometer, DIP switch and remote control

**Light values -**

**Remote control:** 100 - 1000 Lux

**Extension of the**

**detection area:** with Slave devices

**Area of coverage:** circular 360°

**Range of coverage**

**Ø H 2.5 m / T = 18°C:** seated 6.4 m / tangential 24 m / radial 8 m

**Recommended height**

**for mounting:** 2 - 3 m

**Mixed light measurement:** daylight + artificial light measurement

**Lux values -**

**Potentiometer:** 10 - 2000 Lux

• Channels 1 and 2 for light switching, brightness-controlled

• Channel 3 selectable: blackboard lighting or HVAC

• Channels 2 and 3 potential-free

**Type of contact:** NOC/with pretravel tungsten contact, µ-Contact

**Contact load:** 3000 W, cos φ=1 /

1500 VA, cos φ=0.5

**Time-settings:** 5 - 90 min / Test with remote control

1 - 60 min / Test with potentiometer

**Dimensions H x Ø:**

SM 85 x 124 mm

FC 100 x 117 mm

**Visible portion when**

**built into ceiling:** H 37 x Ø 117 mm

## CE Declaration of Conformity:

This product respects the directives concerning

1. electromagnetic compatibility (2004/108/EU)

2. low voltage (2006/95/EU)

3. restriction of the use of certain hazardous substances in electrical and electronic equipment (2011/65/EU)

## 12. Article / Part nr. / Accessory

Type	SM	FC	FM
PD4-M-3C-TRIO (Master)	92740	92745	-
PD4-S (Slave)	92142	92254	92163

**LUXOMAT® Remote control:**

IR-PD4-TRIO-3C (incl. wall bracket) 92102

IR-Adapter for Smartphones 92726

**Accessory:**

SM-Socket IP54 for 92740 92386

Wire basket BSK for SM 92740 92467

Wire basket BSK for FC 92745 92199

Wall bracket for remote control as replacement 92100

## 13. LED function displays

LED	Colour	Function	Display
VI	red	Display of movement	Flashing: motion is detected
V	green	Display of light status channel 1	Flashes twice per second: - <i>bright enough (Light OFF/ too bright (Light ON))</i> Flashes once per second: - <i>Test period for measured light value active</i>
IV	white	Semi automatic and automatic channel 1+2	Shines in semi-automatic mode
III	white	Semi automatic and automatic channel 3	Shines in semi-automatic mode
II	green	Display of light status channel 2	Flashes twice per second: - <i>bright enough (Light OFF/ too bright (Light ON))</i> Flashes once per second: - <i>Test period for measured light value active</i>
I	red	INI ON/OFF	illuminates if function activated, i.e. light is OFF during self-test cycle
all LEDs	Confirmation	Confirmation	Flash once per second: - <i>correct input</i> flashes twice per second: - <i>wrong input</i> flashes 3 times/once per second: - <i>Reset in closed mode</i> flashes twice/once per second: - <i>double closed</i>
LED2/LED5	Light measurement	Light measurement	Green LEDs flash by turns: - <i>light measuring and calculating cut-off threshold</i>
all LEDs	Status	Status	Flash once per second: - <i>Detector is double closed</i>
all LEDs	Confirmation mode 1	Confirmation mode 1	blink once
all LEDs	Confirmation mode 2	Confirmation mode 2	blink twice
all LEDs	Confirmation mode 3	Confirmation mode 3	blink three times

## 14. Fault-finding

### Permanently flashing

Check whether DIP3 switch (RESET) is set to "ON"

Reset to "OFF" if necessary

## 15. Putting into operation of the remote control IR-PD4-TRIO-3C (optional)

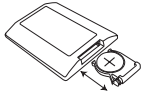

### 1. Check Battery:

Open battery compartment by pressing the plastic springs together and removing the battery-holder.

**Caution:** Settings with remote control supersede the settings by potentiometers.



IR-PD4-TRIO-3C



Wall bracket for remote control IR-PD4-TRIO-3C

## 16. Settings by remote control

Before pressing a setup button, the relevant channel (1, 2 or 3) must be selected by pressing the respective CH button.

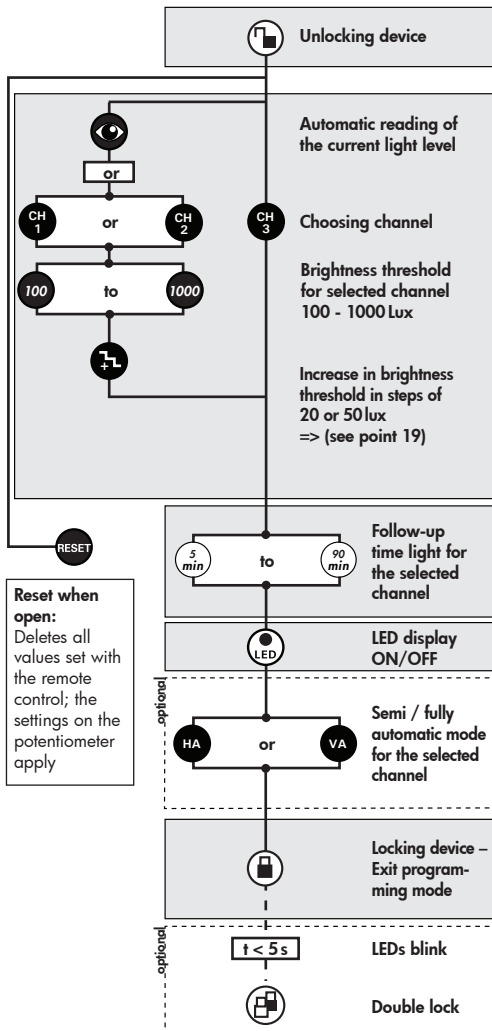

## 17. Choosing mode of operation

The device can be operated in several modes:

Factory settings mean Mode 1 is active. In this mode, 3 push buttons are available: push button 1 for switching channel 1 (lighting group 1), push button 3 for switching channel 3 (blackboard lighting or HVAC operation) and push button 2 for switching channel 2 (lighting group 2). This is connected to the "R" terminal. In addition, slave devices for extending the detection area can be connected to the "R" terminal.

In Mode 2, two push buttons are available. Push button 1 is used for classroom lighting (lighting groups 1 and 2), and push button 3 switches channel 3 (blackboard lighting/HVAC). Slave devices can be connected to the "R" terminal.

Mode 3 corresponds to Mode 1, except that in Mode 3, slave devices cannot be connected to the "R" terminal.



Pressing the SLAVE/PB button when open will switch between the modes. The currently-active mode will be displayed by the LEDs blinking:  
1x = Mode 1, 2x = Mode 2, 3x = Mode 3.



Channel 3 can be switched between brightness-dependent switching (blackboard lighting) and brightness-independent switching (HVAC mode), by pressing the "double lock" button for over 5 seconds (factory setting is for blackboard lighting). When switching modes, the detector LEDs blink once for blackboard lighting and three times for HVAC mode.

## 18. Explanation of the key functions



### Test function

Activation of the test function  
Reset for deactivation



### Resetting when locked

Reset – determine of all timers, switching off the channels



### Double lock

This function blocks the PD4-M-3C-TRIO permanently (all LEDs are flashing).

t < 5 s



Proceed to exit this mode: reset the hardware using DIP switch 3.



### Channel ON/OFF

## 19. Brightness threshold

Each time the push button is pressed, the device increases the current switch-on value in increments of 20 lux for a current switch-on value of <100 lux and in increments of 50 lux for a current switch-on value of >100 lux.

## 20. Fully / Semi automatic mode

(see DIP switch functions and IR-PD4-TRIO-3C on page 1)

### Fully automatic operation

In this operating mode, the lighting switches automatically on and off for increased comfort, depending on presence and brightness.  
- If "blackboard lighting" is selected, channel 3 switches on when channel 1 or 2 does.  
- If "HVAC" is selected, channel 3 switches on when movement is detected independently of light levels.

### Semiautomatic operation

In this mode, all 3 channels only switch on after manual operation, for improved energy saving.

Switching off takes place automatically or manually.

Semi-automatic mode behaves essentially in the same way as full automatic mode.

The channels can be switched back on automatically if there is movement in the 10 seconds after the end of the follow-up time. After this time has elapsed, the respective push button must be pressed to switch on the channels.