

B.E.G.**LUXOMAT®**

PD4N-M-DACO-1C DALI-2

Prod.No. 93463 EAN: 4007529934638

- Voltage: 230 V AC $\pm 10\%$ 50 Hz
- Dimensions: \varnothing 106 x 95 mm
- Power consumption: approx. 2 W

Areas of application

- entrance halls
- corridors/hallways
- small offices
- open-plan offices
- conference rooms
- classrooms/seminar rooms
- sports halls/ storage rooms

Order data

Designation	Colour	Art.No
PD4N-M-DACO-1C DALI-2	white	93463

Accessories

Designation	Colour	Art.No
BLE-IR-Adapter	black	93067
IR-Adapter for Smartphones	black	92726
IR-PD-DALI-1C	-	92116
IR-PD-DALI	-	92094
IR-PD-DALI-LD	-	92652
IR-PD-DALI-Mini	-	92112
SM socle mounting set IP54 PD4N H	anthracite	93786
SM socle mounting set IP54 PD4N H	white	93465
SM socle mounting set IP54 PD4N H	black	93788
SM socle mounting set IP54 PD4N H	traffic white	93787
SM socle mounting set IP65 PD4N	white	93314

Corridor lens PD4N type A, Cover ring	traffic white	93742
Corridor lens PD4N type A, Cover ring	anthracite	93741
Corridor lens PD4N type A, Cover ring	black	93743
Corridor lens PD4N type A	white	93073
lens PD4N, Cover ring	anthracite	93731
lens PD4N, Cover ring	black	93733
lens PD4N, Cover ring	traffic white	93732
Wire basket BSK (Ø 200 x 90 mm)	white	92199
Wall holder PD2N/4N Typ A	traffic white	93702
Wall holder PD2N/4N Typ A	anthracite	93701
Wall holder PD2N/4N Typ A	white	93700
Wall holder PD2N/4N Typ A	black	93703
Wall holder PD2N/4N Typ A	white	93164

Technical data

Voltage:	230 V AC \pm 10% 50 Hz
Dimensions:	Ø 106 x 95 mm
Power consumption:	approx. 2 W
Slave devices:	up to 8
Detection area:	horizontal 360° (Ceiling mounting) max. Ø 24 m across max. Ø 8 m towards max. Ø 6.4 m seated
Range:	
Monitored area (tangential movement):	450 m ² / 2.5 m mounting height
Mounting height min./max./recommended:	2 m / 10 m / 2.5 m
Degree / class of protection:	IP20 / Class II
Impact strength:	IK04
Ambient temperature:	-25 °C to +50 °C
Housing:	polycarbonate, UV-resistant
Material color:	white mat, similar to RAL9010

Channel 1 (lighting control)

DALI output:	80 mA (guaranteed), 125 mA (max.), Shut-down mechanism
Supported control gear:	DT0, DT5, DT6, DT7
Supported control devices:	- (single master)
Follow-up time:	1 min - 150 min 10 - 30 % / OFF
Orientation light:	/ 5 min - 60 min / ∞
Brightness set value:	10 - 2500 Lux

Channel 2 (HVAC or lighting control)

Switching power:	2300 W, $\cos \varphi$ = 1 1150 VA, $\cos \varphi$ = 0.5 800 W LED max. inrush current I_p (20 ms) = 165 A
Type of contact:	1x μ -contact, dry, bistable

Product information

Occupancy detector with integrated DALI application
controller for energy-efficient lighting control

DALI-2 certified product

Integrated DALI power supply

DALI interface for controlling digital, dimmable ECGs in
broadcast mode

Manual switching or dimming via conventional pushbuttons

Bidirectional IR communication enables fast integration into
the project management function of the B.E.G. One app

Complete range of functions can only be activated using the
BLE-IR-Adapter and a compatible Smartphone or Tablet
(Android, iOS).

Semi-automatic, full automatic, presence-independent or
light-independent mode adjustable

Powerful switching relay for different operating modes, e.g.
Cut-off function for DALI ballasts, HVAC, blackboard
illumination.

Adjustable regulation dynamics (minimum and maximum
values)

Adjustable speed and delay of the regulation

Single master version, not networkable

Detection area can be extended by using slave devices

Mixed light measurement with internal and external light
sensor

DALI output power can be increased with accessories

Integrated daylight harvesting circuit (or switch output)

Adjustable switch-on value

Last value - Reminder function for switch-on value

Adjustable brightness set value and reflection factor

Indication of the current light sensor value in the B.E.G. One
App

Self-check and display of device errors in the B.E.G. One App

Status LEDs can be activated / deactivated

PIN code

Corridor function - Deactivates the possibility to switch off the
light via the push-button

Number of DALI participants can be determined quickly and
reliably via the B.E.G. Online DALI Line Planner

Avoidance of standby losses of the lighting system in

Follow-up time: 5 min - 120 min, Alarm pulse, Pulse
Light measuring: Mixed light measuring

accordance with EnEV DIN V 18599-4

Software is backwards compatible with the first generation (except DSI, double lock and corridor function)

Factory setting 10 min follow-up time and 500 lux brightness set value

Including pre-assembled spring clamp with strain relief and contact protection cap for recessed ceiling mounting

Accessory for surface mounting available

Accessories for wall mounting optionally available

Further accessories for colour matching optionally available

Application examples:

entrance halls, corridors/hallways, small offices, open-plan offices, conference rooms, classrooms/seminar rooms, sports halls/ storage rooms

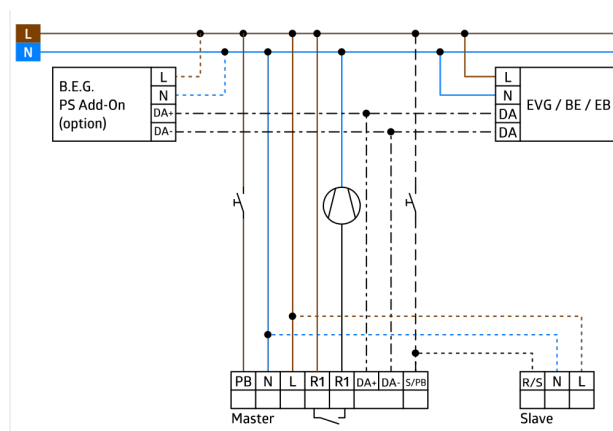
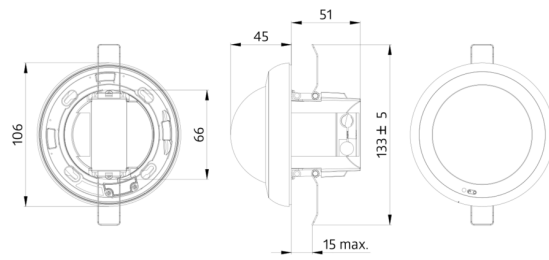

Accessories



BLE-IR-Adapter
Art.No: 93067

Dimensions: 40 x 55 x 103 mm
Material color: black
Frequency: 2.4 GHz ISM band, GFSK
0.2 dBm + 5.3 dBi = 5.5 dBm



IR-Adapter for Smartphones
Art.No: 92726

Dimensions: 47 x 19 x 10 mm
Degree / class of protection: IP20
Ambient temperature: -20 °C to +40 °C



IR-PD-DALI-1C
Art.No: 92116

Battery: 3.0 V Lithium CR2032 (inclusive)
Dimensions: 80 x 60 x 8 mm
Material color: -



IR-PD-DALI
Art.No: 92094

Battery: 3.0 V Lithium CR2032 (inclusive)
Dimensions: 80 x 60 x 8 mm
Material color: -

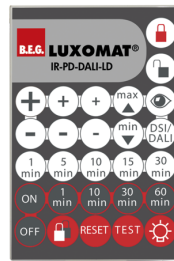

IR-PD-DALI-LD
Art.No: 92652

Battery: 3 x 1.5 V Micro AAA (not included)
Dimensions: 83 x 53 x 17 mm
Material color: -



IR-PD-DALI-Mini
Art.No: 92112

Battery: 3.0 V Lithium CR2032 (inclusive)
Dimensions: 57 x 35 x 7 mm
Material color: -



SM socle mounting set IP54 PD4N H
Art.No: 93786

Dimensions: Ø 110 x 45 mm
Degree / class of protection: IP54
Material color: anthracite, similar to RAL7016



SM socle mounting set IP54 PD4N H
Art.No: 93465

Dimensions: Ø 110 x 45 mm
Degree / class of protection: IP54
Material color: white, similar to RAL9010



SM socle mounting set IP54 PD4N H
Art.No: 93788

Dimensions: Ø 110 x 45 mm
Degree / class of protection: IP54
Material color: black, similar to RAL9005



SM socle mounting set IP54 PD4N H
Art.No: 93787

Dimensions: Ø 110 x 45 mm
Degree / class of protection: IP54
Material color: traffic white, similar to RAL9016



SM socle mounting set IP65 PD4N
Art.No: 93314

Dimensions: 133 x 133 x 69 mm
Degree / class of protection: IP65
Material color: white



Corridor lens PD4N type A, Cover ring
Art.No: 93742

Detection area: horizontal 360° (Ceiling mounting)
Range: max. Ø 40 m across
max. Ø 20 m towards
Monitored area (tangential movement): 250 m² / 2.5 m mounting height



Corridor lens PD4N type A, Cover ring
Art.No: 93741

Detection area: horizontal 360° (Ceiling mounting)
Range: max. Ø 40 m across
max. Ø 20 m towards
Monitored area (tangential movement): 250 m² / 2.5 m mounting height



Corridor lens PD4N type A, Cover ring
Art.No: 93743

Detection area: horizontal 360° (Ceiling mounting)
Range: max. Ø 40 m across
max. Ø 20 m towards
Monitored area (tangential movement): 250 m² / 2.5 m mounting height



Corridor lens PD4N type A
Art.No: 93073

Detection area: horizontal 360° (Ceiling mounting)
Range: max. Ø 40 m across
max. Ø 20 m towards
Monitored area (tangential movement): 250 m² / 2.5 m mounting height



lens PD4N, Cover ring
Art.No: 93731

Detection area: horizontal 360° (Ceiling mounting)
Range: max. Ø 24 m across
max. Ø 8 m towards
max. Ø 6.4 m seated
Monitored area (tangential movement): 450 m² / 2.5 m mounting height



lens PD4N, Cover ring
Art.No: 93733

Detection area: horizontal 360° (Ceiling mounting)
Range: max. Ø 24 m across
max. Ø 8 m towards
max. Ø 6.4 m seated
Monitored area (tangential movement): 450 m² / 2.5 m mounting height



lens PD4N, Cover ring
Art.No: 93732

Detection area: horizontal 360° (Ceiling mounting)
Range: max. Ø 24 m across
max. Ø 8 m towards
max. Ø 6.4 m seated
Monitored area (tangential movement): 450 m² / 2.5 m mounting height



Wire basket BSK (Ø 200 x 90 mm)
Art.No: 92199

Dimensions: Ø 200 x 90 mm
Impact strength: IK09
Housing: coated steel basket

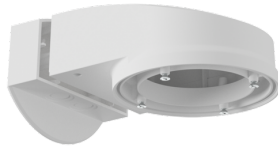

Wall holder PD2N/4N Typ A
Art.No: 93702

Dimensions: 133 x 106 x 66 mm
Degree / class of protection: IP54 /
Class II
Housing: polycarbonate, UV-resistant

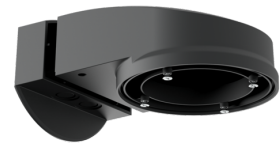

Wall holder PD2N/4N Typ A
Art.No: 93701

Dimensions: 133 x 106 x 66 mm
Degree / class of protection: IP54 / Class
II
Housing: polycarbonate, UV-resistant

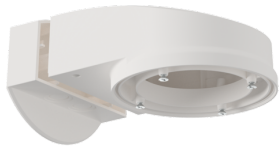

Wall holder PD2N/4N Typ A
Art.No: 93700

Dimensions: 133 x 106 x 66 mm
Degree / class of protection: IP54 / Class
II
Housing: polycarbonate, UV-resistant

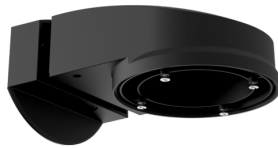

Wall holder PD2N/4N Typ A
Art.No: 93703

Dimensions: 133 x 106 x 66 mm
Degree / class of protection: IP54 /
Class II
Housing: polycarbonate, UV-resistant



Wall holder PD2N/4N Typ A
Art.No: 93164

Dimensions: 133 x 106 x 66 mm
Degree / class of protection: IP54 /
Housing: polycarbonate, UV-resistant