

B.E.G.**LUXOMAT®**

PD2N-S

Prod.No. 93240 EAN: 4007529932405

- Voltage: 110 - 240 V AC 50 / 60 Hz
- Dimensions: Ø 82 x 86 mm
- Power consumption: approx. 0.2 W

Order data

Designation	Colour	Art.No
PD2N-S	white	93240

Accessories

Designation	Colour	Art.No
SM socle mounting set IP54 PD2N H	white	93454
SM socle mounting set IP54 PD2N H	black	93783
SM socle mounting set IP54 PD2N H	traffic white	93782
SM socle mounting set IP54 PD2N H	anthracite	93781
Cover ring PD2N FM	black	93763
Cover ring PD2N FM	traffic white	93762
Cover ring PD2N FM	anthracite	93761
Cover ring PD2N FM	white	93760
Wire basket BSK (Ø 200 x 90 mm)	white	92199
Blinds PD2N/PD3N		37367
Wall holder PD2N/4N Typ A	traffic white	93702
Wall holder PD2N/4N Typ A	anthracite	93701

Wall holder PD2N/4N Typ A	white	93700
Wall holder PD2N/4N Typ A	black	93703
Wall holder PD2N/4N Typ A	white	93164
SM socket for Wall holder	white	93192
Pendulum mounting set PD2/3/4 SM	white	93179
Adapter ring PD2N FM		93089

Technical data

Voltage:	110 - 240 V AC 50 / 60 Hz
Dimensions:	Ø 82 x 86 mm
Power consumption:	approx. 0.2 W
Detection area:	horizontal 360° (Ceiling mounting) max. Ø 10 m across
Range:	max. Ø 6 m towards max. Ø 4 m seated
Monitored area (tangential movement):	78 m ² / 2.5 m mounting height
Mounting height min./max./recommended:	2 m / 5 m / 2.5 m
Degree / class of protection:	IP20 / Class II
Impact strength:	IK05
Ambient temperature:	-25 °C to +50 °C
Housing:	polycarbonate, UV-resistant
Material color:	white mat, similar to RAL9010
Pulse interval:	2 or 9 sec

Product information

Slave device detector with circular detection area

For extending the detection area of a Master device

Trigger pulse to master device upon detected movement independent of the ambient light level

Compatible with 230 V devices. Concerning exceptions please see the respective master device.

Application examples:

small offices, staircases, open-plan offices, conference rooms, classrooms/seminar rooms

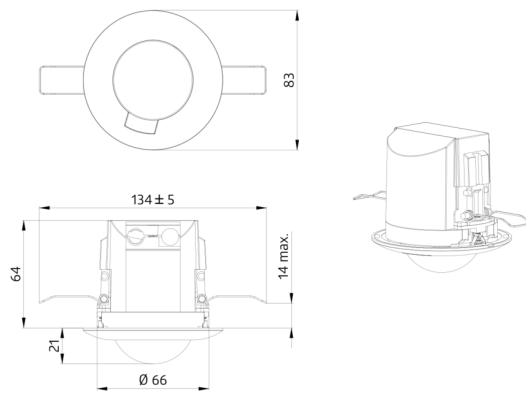

Accessories



SM socle mounting set IP54 PD2N H

Art.No: 93454

Dimensions: Ø 110 x 65 mm
Degree / class of protection: IP54
Material color: white, similar to RAL9010

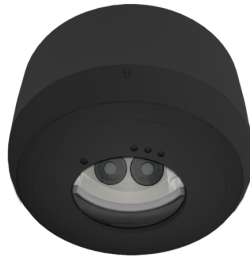

SM socle mounting set IP54 PD2N H

Art.No: 93783

Dimensions: Ø 110 x 65 mm
Degree / class of protection: IP54
Material color: black, similar to RAL9005



SM socle mounting set IP54 PD2N H

Art.No: 93782

Dimensions: Ø 110 x 65 mm
Degree / class of protection: IP54
Material color: traffic white, similar to RAL9016

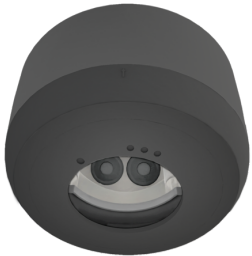

SM socle mounting set IP54 PD2N H

Art.No: 93781

Dimensions: Ø 110 x 65 mm
Degree / class of protection: IP54
Material color: anthracite, similar to RAL7016



Cover ring PD2N FM

Art.No: 93763

Dimensions: Ø 106 x 20 mm
Impact strength: IK05
Housing: polycarbonate, UV-resistant

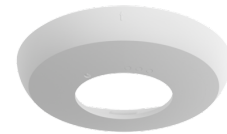

Cover ring PD2N FM

Art.No: 93762

Dimensions: Ø 106 x 20 mm
Impact strength: IK05
Housing: polycarbonate, UV-resistant

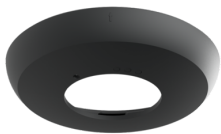

Cover ring PD2N FM

Art.No: 93761

Dimensions: Ø 106 x 20 mm
Impact strength: IK05
Housing: polycarbonate, UV-resistant

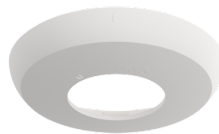

Cover ring PD2N FM

Art.No: 93760

Dimensions: Ø 106 x 20 mm
Impact strength: IK05
Housing: polycarbonate, UV-resistant

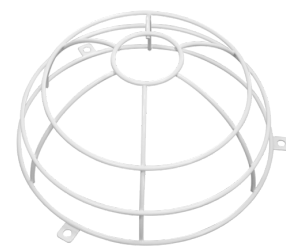

Wire basket BSK (Ø 200 x 90 mm)

Art.No: 92199

Dimensions: Ø 200 x 90 mm
Impact strength: IK09
Housing: coated steel basket

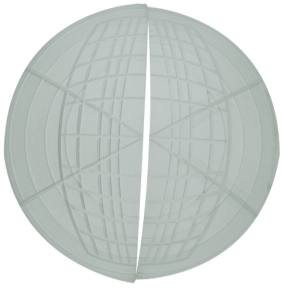

Blinds PD2N/PD3N

Art.No: 37367

Housing: ABS

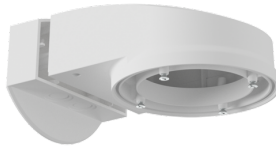

Wall holder PD2N/4N Typ A

Art.No: 93702

Dimensions: 133 x 106 x 66 mm
Degree / class of protection: IP54 / Class II
Housing: polycarbonate, UV-resistant

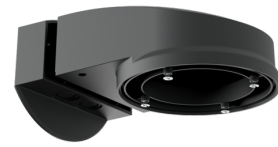

Wall holder PD2N/4N Typ A

Art.No: 93701

Dimensions: 133 x 106 x 66 mm
Degree / class of protection: IP54 / Class II
Housing: polycarbonate, UV-resistant

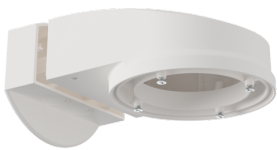

Wall holder PD2N/4N Typ A

Art.No: 93700

Dimensions: 133 x 106 x 66 mm
Degree / class of protection: IP54 / Class II
Housing: polycarbonate, UV-resistant

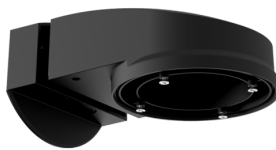

Wall holder PD2N/4N Typ A

Art.No: 93703

Dimensions: 133 x 106 x 66 mm
Degree / class of protection: IP54 / Class II
Housing: polycarbonate, UV-resistant



Wall holder PD2N/4N Typ A

Art.No: 93164

Dimensions: 133 x 106 x 66 mm
Degree / class of protection: IP54 / Class II
Housing: polycarbonate, UV-resistant



SM socket for Wall holder

Art.No: 93192

Dimensions: 103 x 80 x 26 mm
Housing: polycarbonate, UV-resistant
Material color: white



Pendulum mounting set PD2/3/4 SM

Art.No: 93179

Dimensions: 1 : Ø 113 x 79 mm, 2 : Ø 113 x 34 mm
Housing: polycarbonate, UV-resistant
Material color: white, similar to RAL9010

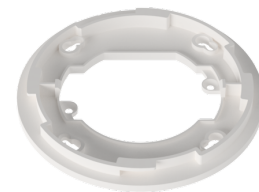

Adapter ring PD2N FM

Art.No: 93089

Dimensions: Ø 101 x 10 mm
Housing: polycarbonate, UV-resistant
Material color: white mat, similar to RAL9010