

**B.E.G.****LUXOMAT®**

## PD2N-M-DACO DALI-2

Prod.No. 93452 EAN: 4007529934522

DALI-2 PIR motion detector with integrated DALI application controller, 360° detection, and a range of up to Ø10m (78 m<sup>2</sup>)

### Areas of application

- small offices
- open-plan offices

### Order data

Designation	Colour	Art.No
PD2N-M-DACO DALI-2	white	93452

### Accessories

Designation	Colour	Art.No
BLE-IR-Adapter	black	93067
IR-Adapter for Smartphones	black	92726
IR-PD-DALI	-	92094
IR-PD-DALI-LD	-	92652
IR-PD-DALI-E	-	92122
IR-PD-DALI-Mini	-	92112
SM socle mounting set IP54 PD2N H	white	93454
SM socle mounting set IP54 PD2N H	black	93783
SM socle mounting set IP54 PD2N H	traffic white	93782
SM socle mounting set IP54 PD2N H	anthracite	93781
Cover ring PD2N FC	black	93773
Cover ring PD2N FC	traffic white	93772

Subject to technical changes

beg-luxomat.com

14.06.2026

Cover ring PD2N FC	anthracite	93771
Cover ring PD2N FM	black	93763
Cover ring PD2N FM	traffic white	93762
Cover ring PD2N FM	anthracite	93761
Cover ring PD2N FM	white	93760
Wire basket BSK (Ø 200 x 90 mm)	white	92199
Wall holder PD2N/4N Typ A	traffic white	93702
Wall holder PD2N/4N Typ A	anthracite	93701
Wall holder PD2N/4N Typ A	white	93700
Wall holder PD2N/4N Typ A	black	93703
Wall holder PD2N/4N Typ A	white	93164
SM socket for Wall holder	white	93192
Blinds PD2N/PD3N		37367
Pendulum mounting set PD2/3/4 SM	white	93179
Adapter ring PD2N FM		93089

## Technical data

Voltage:	230 V AC $\pm$ 10% 50 Hz
Dimensions:	Ø 84 x 85 mm
Power consumption:	approx. 2 W
Slave devices:	up to 8
Detection area:	horizontal 360° (Ceiling mounting) max. Ø 10 m across max. Ø 6 m towards max. Ø 4 m seated
Range:	
Monitored area (tangential movement):	78 m <sup>2</sup> / 2.5 m mounting height
Mounting height min./max./recommended:	2 m / 5 m / 2.5 m
Degree / class of protection:	IP20 / Class II
Impact strength:	IK05
Ambient temperature:	-25 °C to +50 °C
Housing:	polycarbonate, UV-resistant
Material color:	white mat, similar to RAL9010

### Channel 1 (lighting control)

DALI output:	80 mA (guaranteed), 125 mA (max.), Shut-down mechanism
Supported control gear:	DT0, DT5, DT6, DT7
Supported control devices:	- (single master)
Follow-up time:	1 min – 150 min 10 – 30 % / OFF / 5 min – 60 min / $\infty$
Orientation light:	
Brightness set value:	10 – 2500 Lux
Light measuring:	Mixed light measuring

## Product information

Occupancy detector with integrated DALI application controller for energy-efficient lighting control

DALI-2 certified product

Integrated DALI power supply

DALI interface for controlling digital, dimmable ECGs in broadcast mode

Manual switching or dimming via conventional pushbuttons

Bidirectional IR communication enables fast integration into the project management function of the B.E.G. One app

Complete range of functions can only be activated using the BLE-IR-Adapter and a compatible Smartphone or Tablet (Android, iOS).

Semi-automatic, full automatic, presence-independent or light-independent mode adjustable

Adjustable regulation dynamics (minimum and maximum values)

Adjustable speed and delay of the regulation

Single master version, not networkable

Detection area can be extended by using slave devices

Mixed light measurement with internal and external light sensor

DALI output power can be increased with accessories

Integrated daylight harvesting circuit (or switch output)

Adjustable switch-on value

Last value - Reminder function for switch-on value

Adjustable brightness set value and reflection factor

Indication of the current light sensor value in the B.E.G. One App

Self-check and display of device errors in the B.E.G. One App

Status LEDs can be activated / deactivated

PIN code

Corridor function - Deactivates the possibility to switch off the light via the push-button

Number of DALI participants can be determined quickly and reliably via the B.E.G. Online DALI Line Planner

Software is backwards compatible with the first generation (except DSI, double lock and corridor function)

Factory setting 10 min follow-up time and 500 lux brightness set value

Including pre-assembled spring clamp with strain relief and contact protection cap for recessed ceiling mounting

Accessory for surface mounting available

**Application examples:**

small offices, open-plan offices

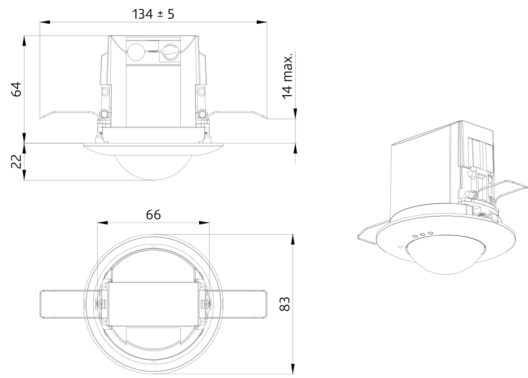

## Accessories



**BLE-IR-Adapter**  
Art.No: 93067

Dimensions: 40 x 55 x 103 mm  
Material color: black  
Frequency: 2.4 GHz ISM band, GFSK  
0.2 dBm + 5.3 dBi = 5.5 dBm



**IR-Adapter for Smartphones**  
Art.No: 92726

Dimensions: 47 x 19 x 10 mm  
Degree / class of protection: IP20  
Ambient temperature: -20 °C to +40 °C



**IR-PD-DALI**  
Art.No: 92094

Battery: 3.0 V Lithium CR2032 (inclusive)  
Dimensions: 80 x 60 x 8 mm  
Material color: -



**IR-PD-DALI-LD**  
Art.No: 92652

Battery: 3 x 1.5 V Micro AAA (not included)  
Dimensions: 83 x 53 x 17 mm  
Material color: -



**IR-PD-DALI-E**  
Art.No: 92122

Battery: 3.0 V Lithium CR2032 (inclusive)  
Dimensions: 80 x 60 x 8 mm  
Material color: -



**IR-PD-DALI-Mini**  
Art.No: 92112

Battery: 3.0 V Lithium CR2032 (inclusive)  
Dimensions: 57 x 35 x 7 mm  
Material color: -



**SM socle mounting set IP54 PD2N H**  
Art.No: 93454

Dimensions: Ø 110 x 65 mm  
Degree / class of protection: IP54  
Material color: white, similar to RAL9010



**SM socle mounting set IP54 PD2N H**  
Art.No: 93783

Dimensions: Ø 110 x 65 mm  
Degree / class of protection: IP54  
Material color: black, similar to RAL9005



**SM socle mounting set IP54 PD2N H**  
Art.No: 93782

Dimensions: Ø 110 x 65 mm  
Degree / class of protection: IP54  
Material color: traffic white, similar to RAL9016



**SM socle mounting set IP54 PD2N H**  
Art.No: 93781

Dimensions: Ø 110 x 65 mm  
Degree / class of protection: IP54  
Material color: anthracite, similar to RAL7016



**Cover ring PD2N FC**  
Art.No: 93773

Dimensions: Ø 82 x 13 mm  
Impact strength: IK05  
Housing: polycarbonate, UV-resistant



**Cover ring PD2N FC**  
Art.No: 93772

Dimensions: Ø 82 x 13 mm  
Impact strength: IK05  
Housing: polycarbonate, UV-resistant



**Cover ring PD2N FC**  
Art.No: 93771

Dimensions: Ø 82 x 13 mm  
Impact strength: IK05  
Housing: polycarbonate, UV-resistant



**Cover ring PD2N FM**  
Art.No: 93763

Dimensions: Ø 106 x 20 mm  
Impact strength: IK05  
Housing: polycarbonate, UV-resistant

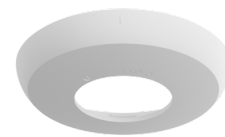

**Cover ring PD2N FM**  
Art.No: 93762

Dimensions: Ø 106 x 20 mm  
Impact strength: IK05  
Housing: polycarbonate, UV-resistant

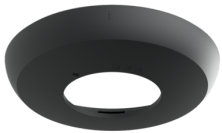

**Cover ring PD2N FM**  
Art.No: 93761

Dimensions: Ø 106 x 20 mm  
Impact strength: IK05  
Housing: polycarbonate, UV-resistant

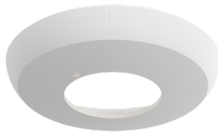

**Cover ring PD2N FM**  
Art.No: 93760

Dimensions: Ø 106 x 20 mm  
Impact strength: IK05  
Housing: polycarbonate, UV-resistant

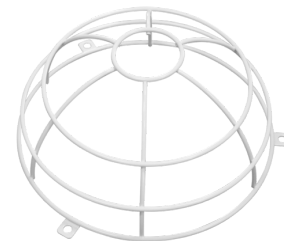

**Wire basket BSK (Ø 200 x 90 mm)**  
Art.No: 92199

Dimensions: Ø 200 x 90 mm  
Impact strength: IK09  
Housing: coated steel basket

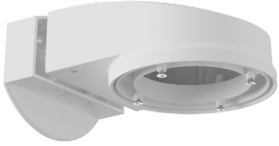

**Wall holder PD2N/4N Typ A**

Art.No: 93702

Dimensions: 133 x 106 x 66 mm  
Degree / class of protection: IP54 / Class II  
Housing: polycarbonate, UV-resistant

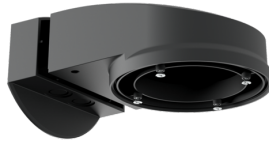

**Wall holder PD2N/4N Typ A**

Art.No: 93701

Dimensions: 133 x 106 x 66 mm  
Degree / class of protection: IP54 / Class II  
Housing: polycarbonate, UV-resistant

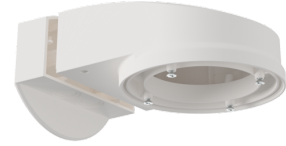

**Wall holder PD2N/4N Typ A**

Art.No: 93700

Dimensions: 133 x 106 x 66 mm  
Degree / class of protection: IP54 / Class II  
Housing: polycarbonate, UV-resistant

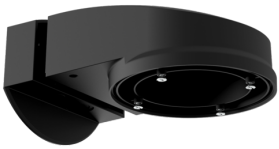

**Wall holder PD2N/4N Typ A**

Art.No: 93703

Dimensions: 133 x 106 x 66 mm  
Degree / class of protection: IP54 / Class II  
Housing: polycarbonate, UV-resistant



**Wall holder PD2N/4N Typ A**

Art.No: 93164

Dimensions: 133 x 106 x 66 mm  
Degree / class of protection: IP54 / Class II  
Housing: polycarbonate, UV-resistant



**SM socket for Wall holder**

Art.No: 93192

Dimensions: 103 x 80 x 26 mm  
Housing: polycarbonate, UV-resistant  
Material color: white

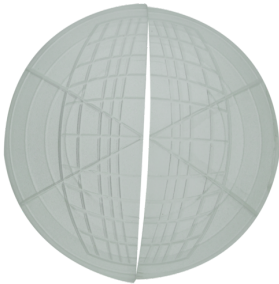

**Blinds PD2N/PD3N**

Art.No: 37367

Housing: ABS



**Pendulum mounting set PD2/3/4 SM**

Art.No: 93179

Dimensions: 1 : Ø 113 x 79 mm, 2 : Ø 113 x 34 mm  
Housing: polycarbonate, UV-resistant  
Material color: white, similar to RAL9010

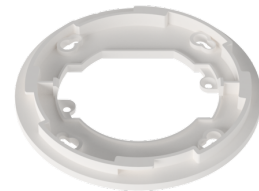

**Adapter ring PD2N FM**

Art.No: 93089

Dimensions: Ø 101 x 10 mm  
Housing: polycarbonate, UV-resistant  
Material color: white mat, similar to RAL9010