

B.E.G. The lighting control professionals



ENERGY-EFFICIENT LIGHTING CONTROL



Do you need more
information?

Visit us online!

Our customer-oriented planning, development, consulting and other services are convincing, as are our high-quality products.

The entire product range is waiting for you and your exciting projects on our website. Would you prefer to be advised first?

No problem. Feel free to contact us! We are looking forward to hearing from you.



www.beg-luxomat.com



Accessories

Find the right accessory for your application - remote-controls, bases, blinds, ball protection baskets, etc.

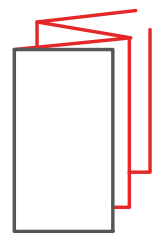

Operati

Find the corre
for all devices

You need more information? Contact us. We will be happy to help you.

Phone 0870 850 5412 | E-Mail info@beguk.com



Operating instructions

Corresponding operating instructions are available online for downloading.

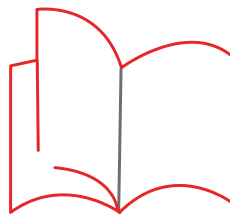

Online catalogues

Would you like to get a more detailed overview of our product range? All print publications are available for you to download.

■ ■ ■ www.beg-luxomat.com ■ ■ ■



B.E.G. Brück Electronic GmbH – We offer solutions and stand by your side as a strong partner

For decades, we at B.E.G. have been developing and manufacturing quality products that bring you more comfort, energy savings and safety.

Today, our B.E.G. occupancy detectors, motion detectors, sensors and actuators control lighting, room temperature, air quality, ventilation and shading fully automatically. They can thus contribute to significant energy savings and safety during building use - without users having to think about it in everyday life.

From manufacturer to solution provider

In addition to our products, we focus on customer-oriented planning, development, consulting and services. B.E.G. has thus long since ceased to be a pure product manufacturer. With over 800 products for numerous applications and their integration into established systems in building automation such as BACnet, NETx, KNX, DALI-2 and Casambi, our product range is extensive and enables a high degree of flexibility.

Our medium-sized electrical engineering company B.E.G. Brück Electronic GmbH, based in Lindlar in the Oberberg region of Germany, has been family-run since 1975. With 13 foreign branches and a total of over 260 employees, we offer customer proximity worldwide. We are known for a wide range of products and accessories, flexible, customer-specific product development and application-relevant, specialised advice for networked products.

Are you looking for a specialist in building systems technology? Contact us, we are glad to be of service to you!

B.E.G. Brück Electronic GmbH

TABLE OF CONTENTS







LUXOMAT®

Motion detectors for outdoor areas	5-9
Ceiling motion	10-15
Twilight switches	16-18
Occupancy detectors	19-26

LUXOMAT® net

DALI devices	27-39
KNX devices	41-50

LEGEND

	Range
	Voltage
	Degree / class of protection
	Switching power
	Power consumption
	Current

MOUNTING TYPES

SM	Surface mounted
FC	Ceiling mounted
FM	Flush mounted

The illustrations in this catalogue regarding the design, size and colour of the devices are not binding. We reserve the right to make changes in technology and design for the purpose of product improvement, as well as errors.



B.E.G. LUXOMAT®



Motion detectors for outdoor areas

Providing light where it is needed

Coming home safely on illuminated paths - that was not always a matter of course. Today, motion detectors belong on every house wall. With our B.E.G. outdoor detectors LUXOMAT® RC-plus next N or LC-plus 280 you get a piece of security and well thought out quality that is constantly evolving with our wealth of experience and customer demands.

Our high-quality B.E.G. motion detectors have a wide range of adjustment options. The movable ball head ensures optimum alignment. The detection range can be individually limited by means of blinds, and sources of interference such as a busy road can be blanked out. The adjustment elements for mechanical range regulation and the potentiometers for twilight and time adjustment are each located on the underside of the sensor head. These additional functions can be set up and adjusted even more conveniently at any time with the op-tionally available remote-controls or the free B.E.G. One app and a BLE/IR adapter via smart-phone.



LUXOMAT® RC-plus next N 130



- Motion detector with 130° detection area and anti-creep zone
- Mechanical range adjustment
- Different follow-up time depending on direction of movement
- Uninterrupted parallel circuit detection of several detectors
- Manual switching via push-button possible
- Adjustable ball head
- Immediate operation using factory settings
- Additional functions can be set up using the optional remote control.
- Socket compatible to RC-plus (next) and Vario
- Easy mounting thanks to plug base
- Wall, ceiling and corner mounting
- Factory settings 3 min and 20 lux

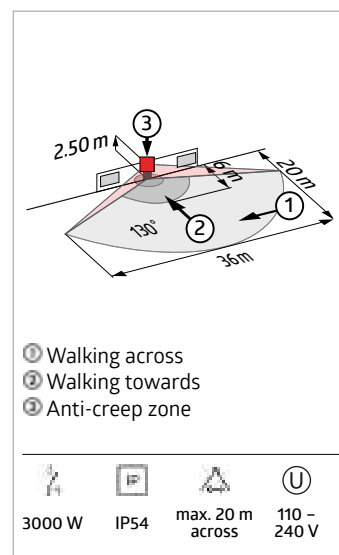

Description	Colour	Part number
RC-plus next N 130	white mat, similar to RAL9010	93321
RC-plus next N 130	black mat, similar to RAL9005	93323
RC-plus next N 130	brown mat, similar to RAL8014	93324

LUXOMAT® RC-plus next N 230



- Motion detector with 230° detection area and anti-creep zone
- Mechanical range adjustment
- Different follow-up time depending on direction of movement
- Uninterrupted parallel circuit detection of several detectors
- Manual switching via push-button possible
- Adjustable ball head
- Immediate operation using factory settings
- Additional functions can be set up using the optional remote control.
- Socket compatible to RC-plus (next) and Vario
- Easy mounting thanks to plug base
- Wall, ceiling and corner mounting
- Factory settings 3 min and 20 lux

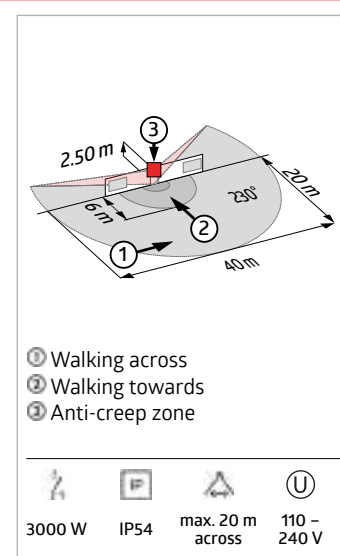

Description	Colour	Part number
RC-plus next N 230	white mat, similar to RAL9010	93331
RC-plus next N 230	black mat, similar to RAL9005	93333
RC-plus next N 230	brown mat, similar to RAL8014	93334
RC-plus next N 230	silver mat, similar to RAL9006	93346

Outdoor motion detectors



LUXOMAT® RC-plus next N 280



- Motion detector with 280° detection area and anti-creep zone
- Mechanical range adjustment
- Different follow-up time depending on direction of movement
- Uninterrupted parallel circuit detection of several detectors
- Manual switching via push-button possible
- Adjustable ball head
- Immediate operation using factory settings
- Additional functions can be set up using the optional remote control.
- Socket compatible to RC-plus (next) and Vario
- Special socket for external corner mounting included
- Easy mounting thanks to plug base
- Wall, ceiling and corner mounting
- Factory settings 3 min and 20 lux

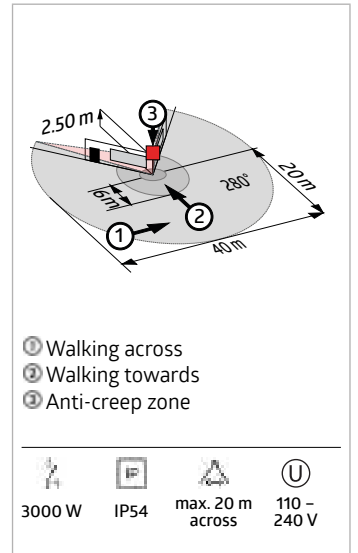

Description	Colour	Part number
RC-plus next N 280	white mat, similar to RAL9010	93341
RC-plus next N 280	black mat, similar to RAL9005	93343
RC-plus next N 280	brown mat, similar to RAL8014	93344



LUXOMAT® LC-plus 280



- Motion detector with downward detection for gapless monitoring
- Adjustable ball head
- Additional functions can be set up using the optional remote control.
- Easy mounting thanks to plug-in base
- Detection area can be restricted with blinds
- Special socket for external corner mounting included
- Factory settings 3 min and 20 lux

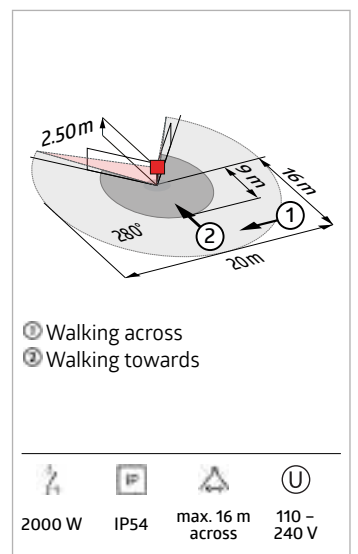

Description	Colour	Part number
LC-plus 280	white mat, similar to RAL9010	91008
LC-plus 280	brown mat, similar to RAL8014	91018
LC-plus 280	black mat, similar to RAL9005	91028
LC-plus 280	silver mat, similar to RAL9022	91048

Outdoor motion detectors



LUXOMAT® LC-Click-N 140 UK 2.000 W



- Motion detector with 140° detection area and 180° anti-creep zone
- Adjustable ball head
- Detection area can be restricted with blinds
- Zero crossing switching
- Simple mounting thanks to plug base
- Cable entry possible from above, from below and from behind
- Can be mounted on standard flush-mount boxes

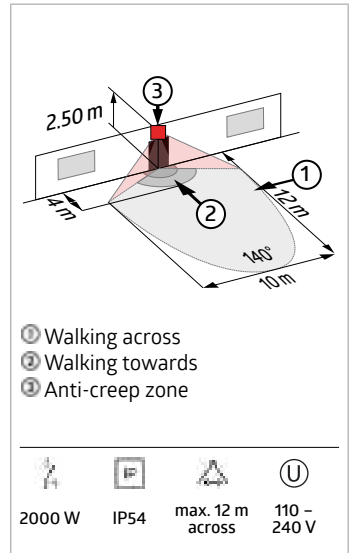

Description	Colour	Part number
LC-Click-N 140 UK 2.000 W	white mat, similar to RAL9010	93041
LC-Click-N 140 UK 2.000 W	black mat, similar to RAL9005	93061



LUXOMAT® LC-Click-N 200 UK 2.000 W



- Motion detector with 200° detection area and 180° anti-creep zone
- Adjustable ball head
- Detection area can be restricted with blinds
- Zero crossing switching
- Simple mounting thanks to plug base
- Cable entry possible from above, from below and from behind
- Can be mounted on standard flush-mount boxes

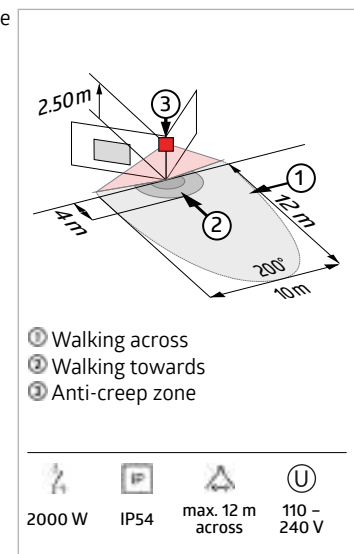

Description	Colour	Part number
LC-Click-N 200 UK 2.000 W	white mat, similar to RAL9010	93042
LC-Click-N 200 UK 2.000 W	black mat, similar to RAL9005	93062

Outdoor motion detectors



LUXOMAT® LC-Click 140



- Motion detector with detection area of 140°
- Adjustable ball head
- Simple mounting thanks to plug base
- Can be mounted on standard flush-mount boxes
- Detection area can be restricted with blinds

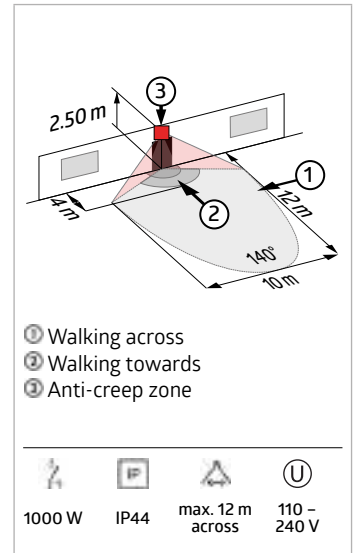

Description	Colour	Part number
LC-Click 140	white mat, similar to RAL9010	91101
LC-Click 140	black mat, similar to RAL9005	91121



LUXOMAT® LC-Click 200



- Motion detector with detection area of 140°
- Adjustable ball head
- Simple mounting thanks to plug base
- Can be mounted on standard flush-mount boxes
- Detection area can be restricted with blinds

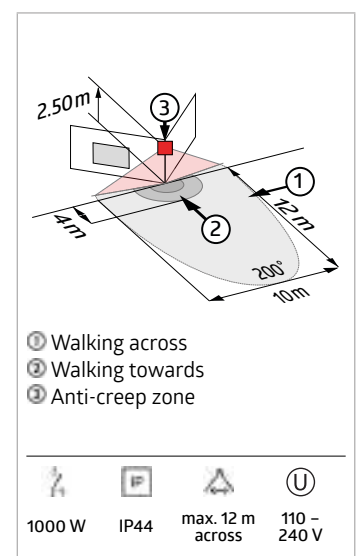

Description	Colour	Part number
LC-Click 200	white mat, similar to RAL9010	91102
LC-Click 200	black mat, similar to RAL9005	91122

B.E.G. LUXOMAT®

Ceiling motion detector for indoor areas

Light as soon as you enter a room, corridor, staircase or cellar.

Both the continuous operation of a light source and the search for the light switch in the dark are no longer necessary where indoor motion detectors provide lighting and safety. A motion detector reliably detects moving heat sources within its detection range. It then switches on the light according to the respective ambient brightness. As soon as no more movement is detected, the detector automatically switches the light off again after the preset follow-up time has elapsed. This reduces the building's energy consumption, in some cases considerably, and allows building users to keep their hands and heads free for other things.

Our detectors are PIR detectors (passive infra-red detectors), which means that they do not emit any radiation themselves, but detect a change in the presence of infrared sources, such as human body.



Ceiling-mounted motion detectors



LUXOMAT® PD3N-1C



- Remote control-capable ceiling motion detector
- One channel for light switching
- Special optical system for detection of even the smallest movements
- Uninterrupted parallel circuit detection of several detectors
- Additional functions can be set up using the optional remote control.
- Factory settings 10 min and 500 lux

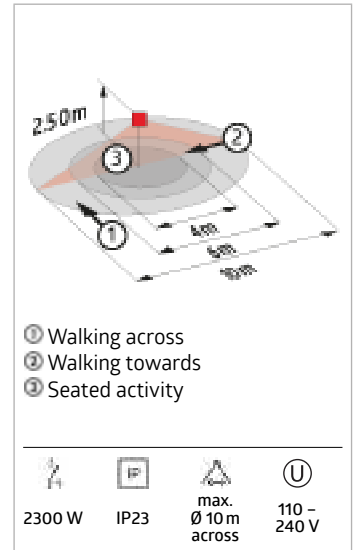

Description	Colour	Part number
PD3N-1C-FC	white mat, similar to RAL9010	92196
PD3N-1C-SM	white mat, similar to RAL9010 IP44	92190

LUXOMAT® PD3N-1C Micro



- Remote control-capable ceiling motion detector with integrated acoustic sensor
- One channel for light switching
- Special optical system for detection of even the smallest movements
- Additional functions can be set up using the optional remote control.

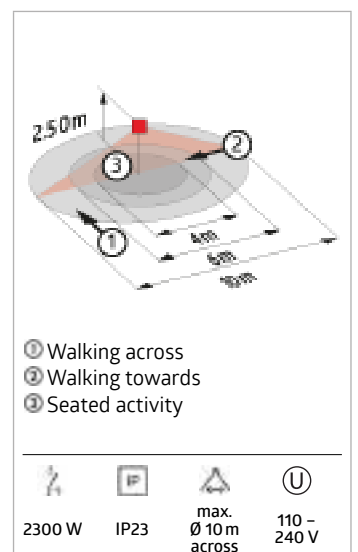

Description	Colour	Part number
PD3N-1C-FC Micro	white mat, similar to RAL9010	92184
PD3N-1C-SM Micro	white mat, similar to RAL9010 IP44	92219

Ceiling-mounted motion detectors



LUXOMAT® PD3N-1C-NO-PF



- Remote control-capable ceiling motion detector
- One potential-free (dry) switching contact
- Special optical system for detection of even the smallest movements
- Additional functions can be set up using the optional remote control.

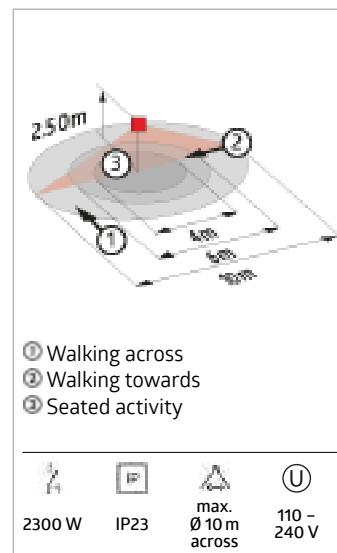

Description	Colour	Part number
PD3N-1C-NO-PF-FC	white mat, similar to RAL9010	92576



LUXOMAT® PD4N-1C



- Remote-control capable ceiling motion detector with large detection range
- One channel for light switching
- Special optical system for detection of even the smallest movements
- Uninterrupted parallel circuit detection of several detectors
- Manual switching via push-button possible
- Additional functions can be set up using the optional remote control.
- Factory settings 10 min and 500 lux

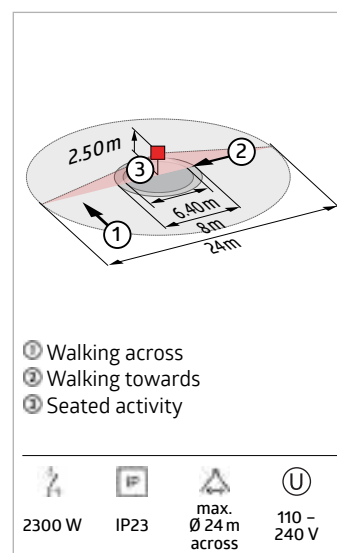

Description	Colour	Part number
PD4N-1C-FC	white mat, similar to RAL9010	92149
PD4N-1C-SM	white mat, similar to RAL9010	92144

Ceiling-mounted motion detectors



LUXOMAT® PD4N-1C-C



- Remote control-capable ceiling motion detector designed for corridors
- One channel for light switching
- Special optical system for detection of even the smallest movements
- Additional functions can be set up using the optional remote control.
- Uninterrupted parallel circuit detection of several detectors
- Factory settings 10 min and 500 lux
- There are markings to ensure correct alignment during installation

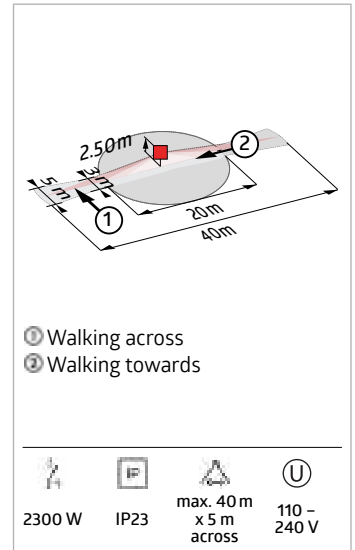

Description	Colour	Part number
PD4N-1C-C-FC	white mat, similar to RAL9010	92274
PD4N-1C-C-SM	white mat, similar to RAL9010	92270



LUXOMAT® PD9-1C



- Mini-motion detector for indoor use
- One channel for light switching
- Easy installation on device
- Power supply passes through the hole in the ceiling for the detector (34 mm Ø)
- Spring clips for quick and easy installation in suspended ceilings and light fittings
- Includes 45 mm cover ring and blinds

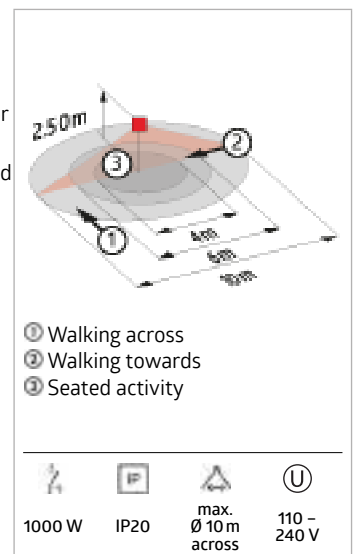

Description	Colour	Part number
PD9-1C-FC	white mat, similar to RAL9010	92902

Ceiling-mounted motion detectors



LUXOMAT® PD9-1C-GH



- Mini-motion detector especially for large mounting heights
- One channel for light switching
- Easy installation on device
- Power supply passes through the hole in the ceiling for the detector (34 mm Ø)
- Spring clips for quick and easy installation in suspended ceilings and light fittings
- Includes 45 mm cover ring and blind

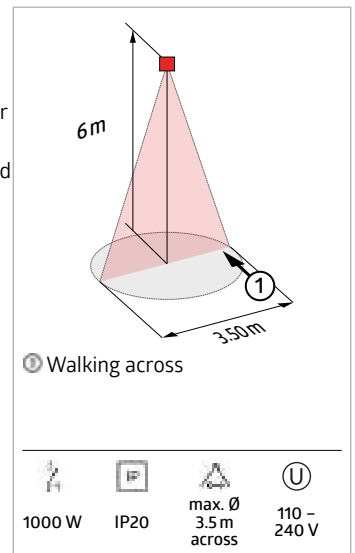

Description	Colour	Part number
PD9-1C-GH-FC	white mat, similar to RAL9010	92934



LUXOMAT® PD3N-2C



- Remote control-capable ceiling motion detector
- One channel for light switching
- One additional potential-free (dry) contact for HVAC
- Additional functions can be set up using the optional remote control.

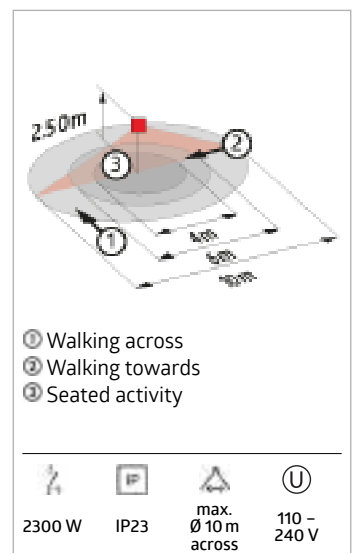

Description	Colour	Part number
PD3N-2C-FC	white mat, similar to RAL9010	92198

Ceiling-mounted motion detectors



LUXOMAT® PD3-MIC-2C



- Ceiling motion detector for indoor use with a 360° detection area
- One channel for light switching
- One additional potential-free (dry) contact for HVAC
- Acoustic sensor independently adjustable

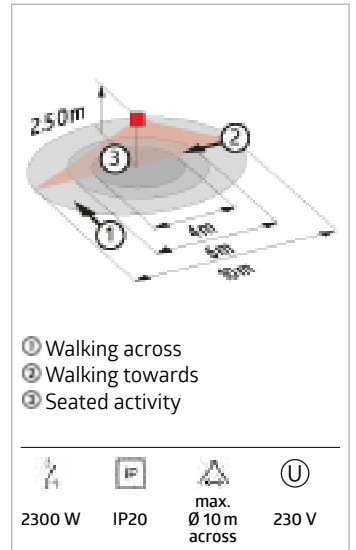

Description	Colour	Part number
PD3-MIC-2C-FC	white mat, similar to RAL9010	96510

LUXOMAT® PD9-1C-12-48V



- Mini-motion detector with operating voltage 12-48 V
- One channel for light switching
- Easy installation on device
- Power supply passes through the hole in the ceiling for the detector (34 mm Ø)
- Spring clips for quick and easy installation in suspended ceilings and light fittings
- Includes 45 mm cover ring and blinds

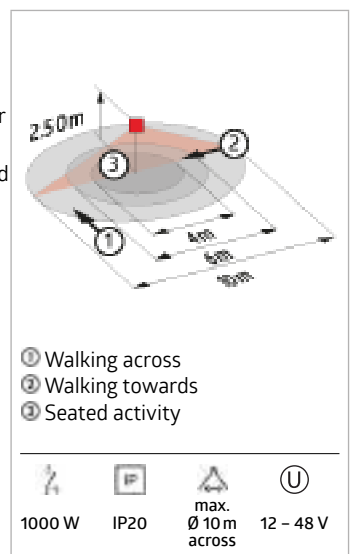

Description	Colour	Part number
PD9-1C-12-48V-FC	white mat, similar to RAL9010	92985

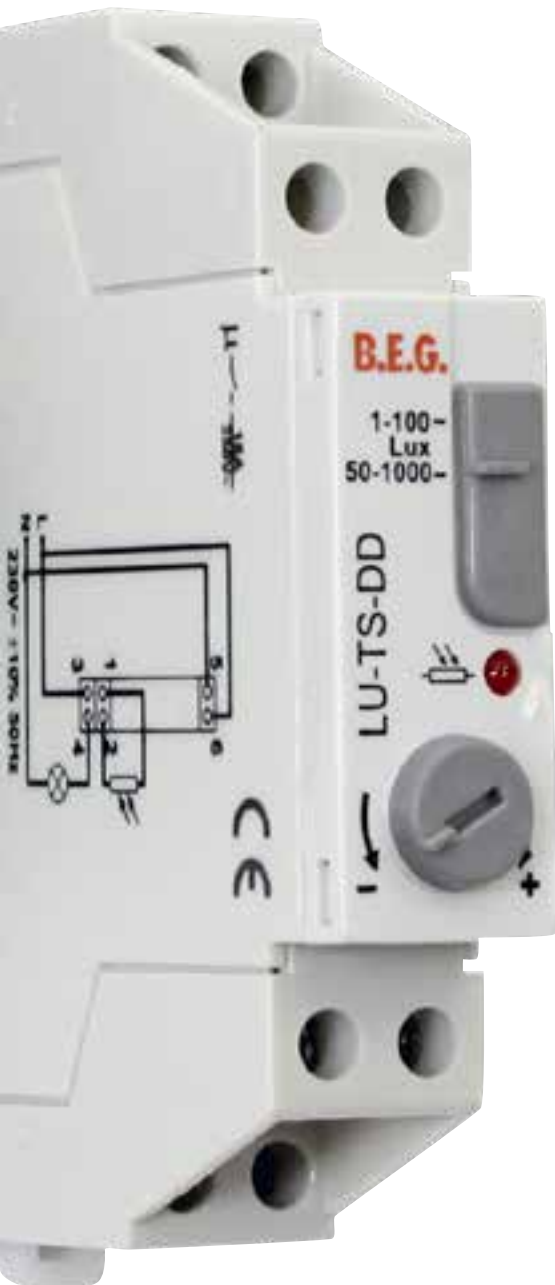
B.E.G. LUXOMAT®

Photocells

Conveniently switching the light with the integrated automatic function

Photocells are the right choice wherever lighting needs to be switched on or off automatically at dawn or at dusk solely on the basis of the brightness value. Light sensors measure the ambient light and switch the lighting on or off depending on the preset twilight value. The light can thus be controlled depending on the twilight and energy is saved.

For this purpose, B.E.G. offers twilight switches for various applications: for profile rails, for device installation, for wall or pole mounting as well as remote-controlled products. In addition to a dimmable version, there is also a photocell with an additional DALI/DSI interface in the range.





LUXOMAT® CdS-T



- Remote control-capable photo electric switch with integrated timer
- Energy-saving period may be programmed with the integrated timer by the touch of a button
- Inputting the current light value by the touch of a button
- Infrared remote control included
- Relay with tungsten pre-make contact, optimised for LED loads

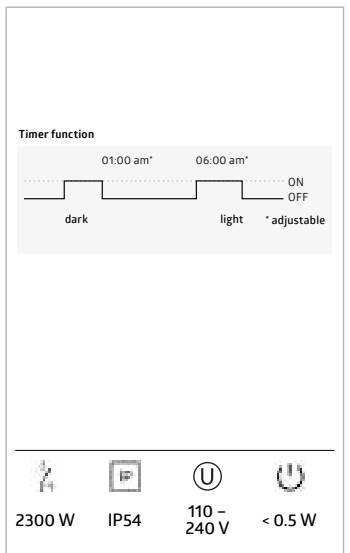

Description	Colour	Part number
CdS-T-SM	white mat, similar to RAL9010	92367



LUXOMAT® CdS



- Photoelectric switch for automatically switching
- Activation and deactivation delay with self-learning deactivation-light value
- Integrated automatic function (10 Lux / 40 sec. activation / 120 sec. deactivation delay)
- LED adjustment aid (without delay) for adjustment of the switch-on threshold
- Light value and activation/deactivation delay may be set from the outside using the potentiometer
- Double cable inlet from underneath possible
- Wall and mast installation

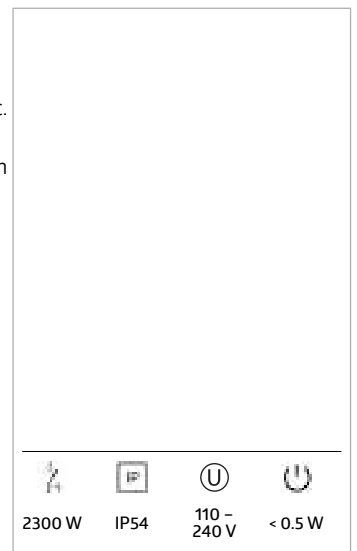

Description	Colour	Part number
CdS-SM	white	92369

Photocells



LUXOMAT® CdS



- Remote control-capable photoelectric switch
- Extra flat form – only 6 mm high
- Adjustable deactivation delay with selflearning deactivation and twilight value

2000 W	IP20	110 – 240 V	< 1 W

Description	Colour	Part number
CdS-FC	white mat, similar to RAL9010	92249



LUXOMAT® CdS-R



- Photoelectric switch with switch relay
- For retrofitting in outdoor lights and for use in branch boxes
- Continuously variable twilight value
- The cable between the photo sensor and electronic unit is around 15 cm long and may be extended to a maximum of 1.50 m

1000 W	Housing IP20	110 – 240 V	< 0.5 W

Description	Colour	Part number
CdS-R	black mat, similar to RAL9005	92365



Occupancy detectors for indoor areas

Occupancy detectors - maximum energy efficiency and pleasant comfort

Buildings play an important role in climate protection. They account for around 38 % of our CO₂ emissions. Occupancy detectors can greatly reduce energy consumption in buildings. Our high-quality B.E.G. occupancy detectors automatically provide optimum lighting conditions in all interior rooms, without having to think about light. An occupancy detector permanently measures the brightness. Installed in the room, it detects when someone enters the room and is able to detect even the smallest movements such as the tap of a finger on a computer mouse.

Whenever movement is detected and the brightness is below the set lux value, the lighting is switched on or maintained. If sufficient daylight illuminates the room, the artificial light can be automatically dimmed or switched off. This results in particularly high energy savings. Unobtrusive in design, ultra-light for large ceiling panels or for difficult lighting situations - we have developed the right detector for almost every customer need.



Ceiling mounted occupancy detectors



LUXOMAT® PD2-M-1C



- Occupancy detector with one potential-free dry contact
- Version as master device
- One channel for light switching
- Detection area can be extended with slave devices
- Manual switching via push-button possible
- Additional functions can be set up using the optional remote control.
- Factory settings 10 min and 500 lux

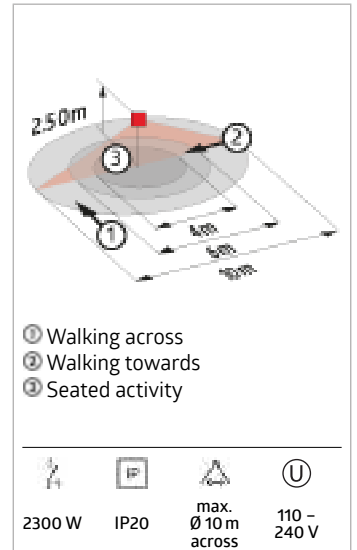

Description	Colour	Part number
PD2-M-1C-FC	white mat, similar to RAL9010	92565
PD2-M-1C-SM	white mat, similar to RAL9010	92550



LUXOMAT® PD4-M-1C



- Occupancy detector with extended detection area
- One potential-free (dry) contact
- Version as master device
- Detection area can be extended with slave devices
- Manual switching via push-button possible
- Additional functions can be set up using the optional remote control.
- Factory settings 10 min and 500 lux

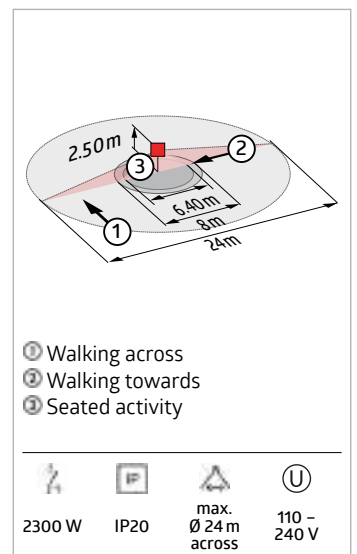

Description	Colour	Part number
PD4-M-1C-FC	white mat, similar to RAL9010	92585
PD4-M-1C-SM	white mat, similar to RAL9010	92580

Ceiling mounted occupancy detectors



LUXOMAT® PD4-M-1C-GH



- Occupancy detector designed for high-bay warehouses
- One potential-free (dry) switching contact
- Version as master device
- Detection area can be extended with slave devices
- **Easy operation with remote control (required)**
- Manual switching via push-button possible
- There are markings to ensure correct alignment during installation
- **When used in high-bay warehouses, care should be taken that, in the cross-aisles of the warehouse, detectors are installed that can detect movement only in the desired aisle locations, by using blinds or other technical arrangements.**
- Factory settings 3 min and 1000 lux

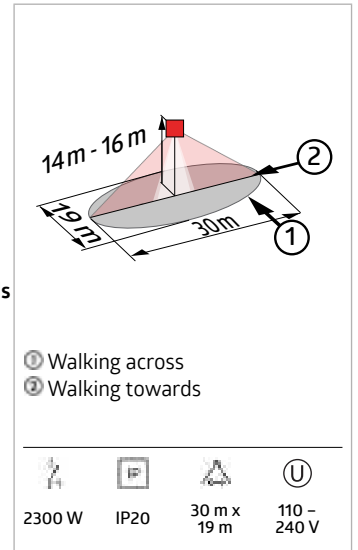

Description	Colour	Part number
PD4-M-1C-GH-SM	white mat, similar to RAL9010	92245



LUXOMAT® PD9-M-1C



- Mini-occupancy detector
- One channel for light switching
- Version as master device
- Detection area can be extended with slave devices
- **Easy operation with remote control (required)**
- Manual switching via push-button possible
- Power supply passes through the hole in the ceiling for the detector (34 mm Ø)
- Spring clips for quick and easy installation in suspended ceilings and light fittings
- Includes 45 mm cover ring and blinds
- Factory settings 10 min and 500 lux

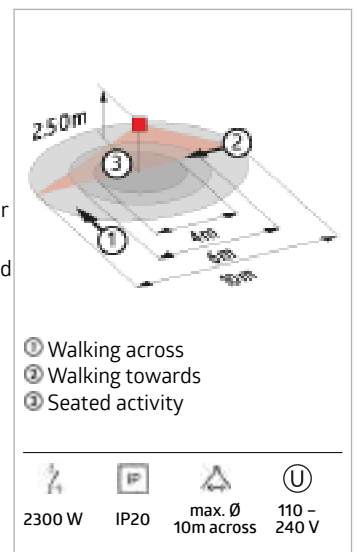

Description	Colour	Part number
PD9-M-1C-FC	white mat, similar to RAL9010	92900

Ceiling mounted occupancy detectors



LUXOMAT® PD9-M-1C-SDB-IP65



- Mini-occupancy detector designed for high-humidity locations
- One potential-free (dry) switching contact
- Version as master device
- One additional Slave device sensor can be directly connected
- Additional functions can be set up using the optional remote control.
- Spring clips for quick and easy installation in suspended ceilings and light fittings
- Includes 45 mm cover ring and blinds

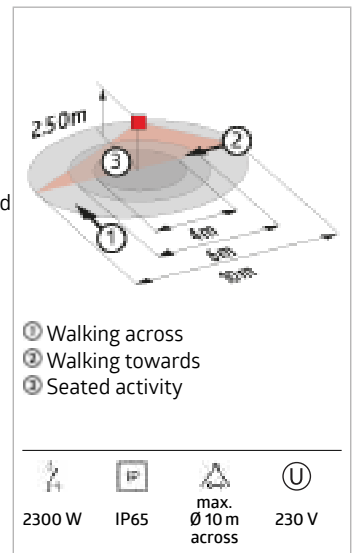

Description	Colour	Part number
PD9-M-1C-SDB-IP65-FC	white mat, similar to RAL9010	92912

LUXOMAT® PICO-N-M-1C



- Mini-occupancy detector, no additional power unit, suitable for high-humidity locations
- One channel for light switching
- Manual switching via push-button possible
- **Easy operation with remote control (required)**
- Version as master device
- Detection area can be extended with slave devices
- Mounting with clip ring (included) for lights or with spring clips for suspended ceilings
- Factory settings 10 min and 500 lux

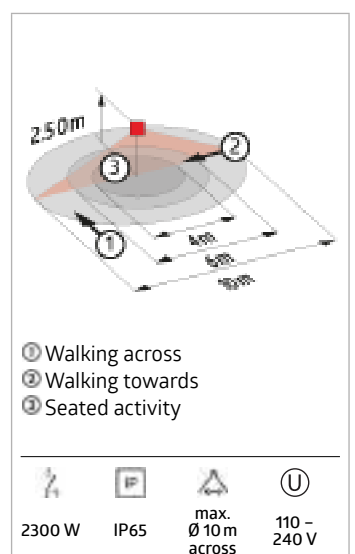

Description	Colour	Part number
PICO-N-M-1C-FC	white mat, similar to RAL9010	93159

Ceiling mounted occupancy detectors



LUXOMAT® PD11-M-1C-FLAT



- Particularly flat occupancy detector without additional power supply
- Visible portion when built into ceiling: height 0.85 mm
- One channel for light switching
- Manual switching via push-button possible
- **Easy operation with remote control (required)**
- Version as master device
- Detection area can be extended with slave devices
- Spring clips for quick and easy installation in suspended ceilings
- Includes blinds and clamp ring for installation into light fittings
- With accessories for flush-mounting in ceiling and exposed concrete
- Factory settings 10 min and 500 lux

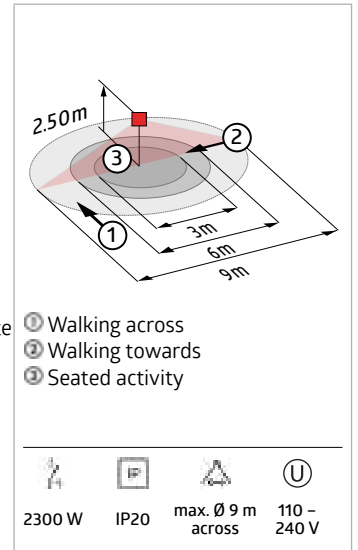

Description	Colour	Part number
PD11-M-1C-FLAT-FC	white mat, similar to RAL9010	92583



LUXOMAT® PD2N-M-1C-LED



- Remote control-capable occupancy detector for inside use with circular detection area
- Integrated LED light as separately adjustable orientation- and night light
- One channel for light switching
- Numerous setting and readout options via the bidirectional B.E.G. smartphone app
- Extension of the detection range possible by using up to 5 other PD2N-M-1C-LED
- Can be used as either Master device or Slave device

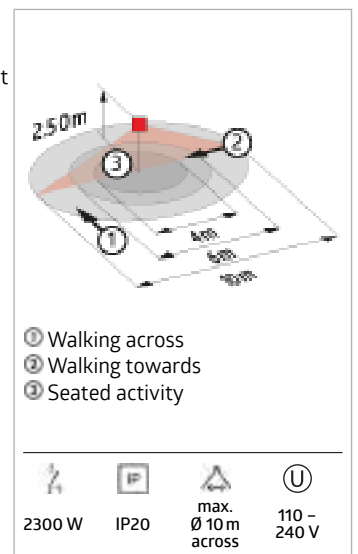

Description	Colour	Part number
PD2N-M-1C-LED-FC	white mat, similar to RAL9010	94055





Sensors/Wall detectors



LUXOMAT® OCCULOG-1C



- VOC indicator for good air quality
- Thanks to the coloured LED display, the current air quality can be quickly recognised even from a distance by means of the LED colours.
- Traffic light function: red - ventilation mandatory, yellow - ventilation recommended, green - good air quality.
- Air quality measuring method VOC or CO₂ equivalent
- Two limit values (yellow/red) for air quality
- In addition, an acoustic signal can be assigned to a limit value.
- One additional potential-free (dry) contact for HVAC
- The supplied 5-button remote control allows selection between three different limit value profiles.
- Parameterisable via accessory BLE-IR adapter 93067

			
1000 W / 6 A	IP20	110 - 240 V	approx. 1W

Description	Colour	Part number
OCCULOG-1C-FC	white mat, similar to RAL9010	93563







LUXOMAT® Indoor 180-R UK covering included

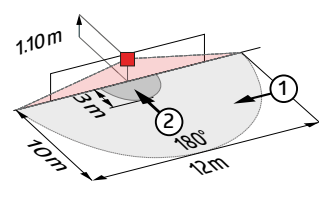

- Wall motion detector with acoustic sensor
- Relay version with three-wire technology
- Acoustic sensor independently adjustable
- Noise automatically extends follow-up time
- With already mounted frame



① Walking across
② Walking towards

			
2300 W	IP20	max. 10 m across	110 - 240 V

Description	Colour	Part number
Indoor 180-R UK covering included	pure white mat, similar to RAL9010	92610

LUXOMAT® Indoor180N-R/2W covering included



- Wall motion detector with acoustic sensor
- With removable frame cover
- Relay version with 2-wire technology thanks to inbuilt battery
- Acoustic sensor independently adjustable
- Noise automatically extends follow-up time
- Mounted frame, removable cover and arc extinction kit included

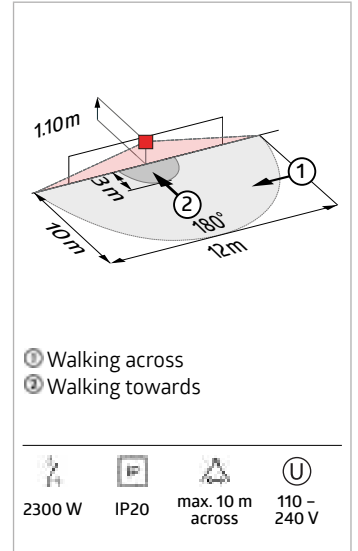

Description	Colour	Part number
Indoor 180N-R/2W-UK covering included	pure white mat, similar to RAL9010	92716



LUXOMAT® Indoor 140-L covering included



- Wall motion detector with acoustic sensor
- Relay version with three-wire technology
- Acoustic sensor independently adjustable
- Noise automatically extends follow-up time
- With already mounted frame

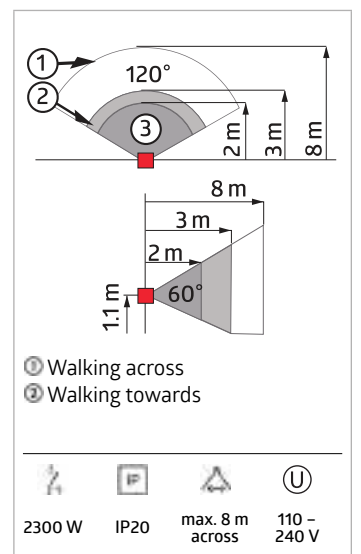

Description	Colour	Part number
Indoor 140-L covering included	pure white mat, similar to RAL9010	94327



Modern lighting control with DALI solutions

DALI is the widely used professional tool for lighting control

Control light systematically via DALI because DALI is convenient, robust and stable. It enables completely individual lighting situations in rooms, e.g. via dimming. Retrofitting DALI is easy if 5-core cables are already available. Then two free cores can be used for the DALI bus of the lighting control system.

B.E.G. DALI compact products are „stand-alone solutions“, they work according to the single-master principle. This means that only the occupancy detector sends the switching/dimming command to the luminaires. The DALI compact occupancy detectors from B.E.G. combine all the components required for energy-efficient lighting control in one housing: the DALI power supply unit, the push-button control, the relay and the application controller are housed directly in the detector. Thanks to the broadcast procedure and the presettings for the brightness setpoint (500 lux) and the follow-up time (10 minutes) that are already programmed ex works, the devices can be put into operation quickly. For optimal integration into a building, we offer a modular system for the majority of our detectors for different application areas. White, traffic white, anthracite and black are available for colour selection. Our DALI-2 certified compact detectors guarantee high functionality with all DALI-2 certified devices worldwide. The DALI portfolio from B.E.G. includes occupancy detectors for almost every challenge: e.g. with detection areas of different sizes, with an additional HVAC channel, with lenses especially for corridors or for great heights. Detectors that can be controlled by radio via the Casambi app. B.E.G. also offers an occupancy detector that can form several groups via just one DALI interface by addressing the connected luminaires. The area to be monitored is enlarged cost-effectively via slave devices.



Optimised range

- More overview thanks to fewer products with increased range of functions

OLD PD4

NEW PD4N

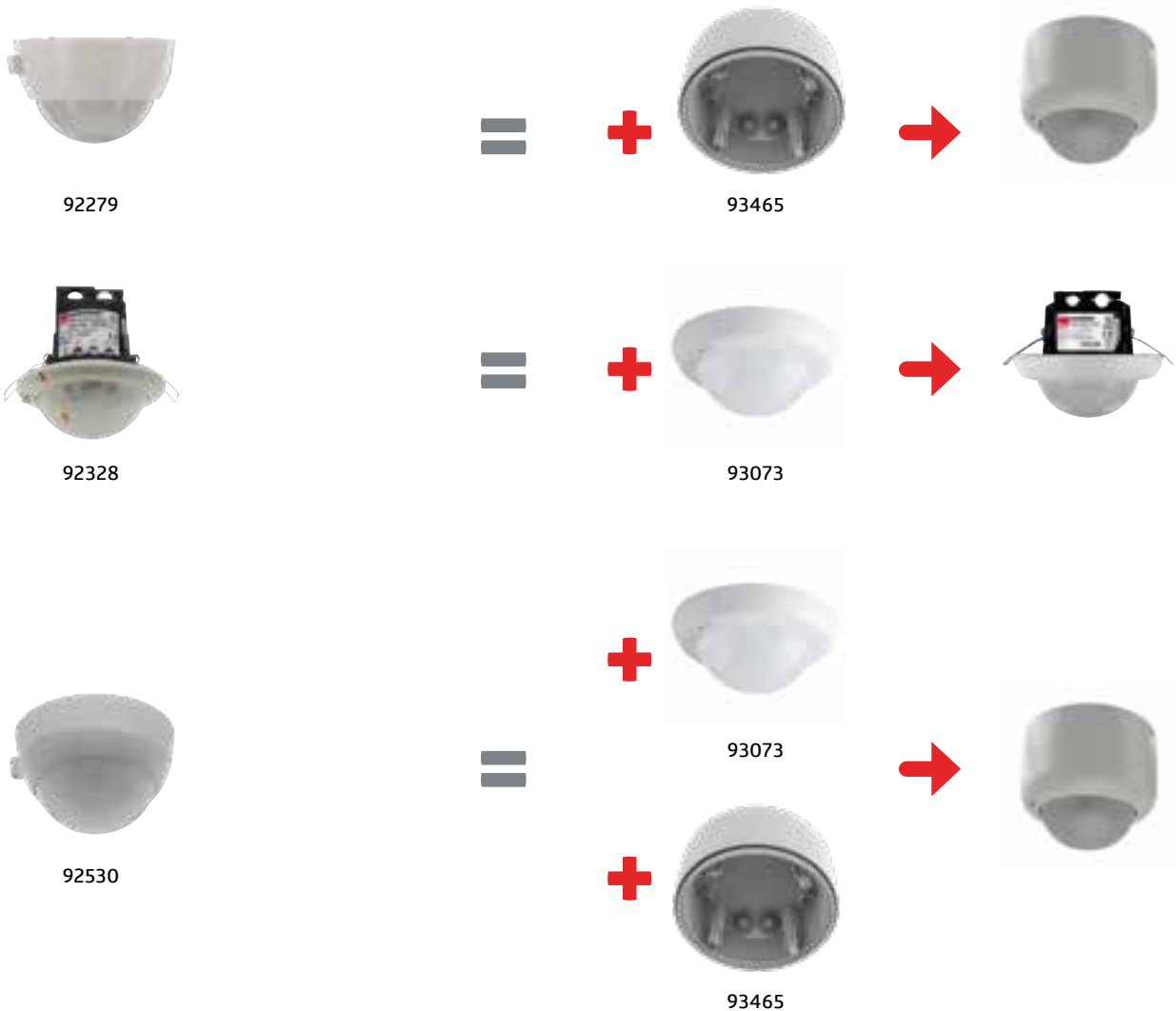

Occupancy detectors DALI Compact



LUXOMAT® PD2N-M-DACO DALI-2



- Occupancy detector with integrated DALI application controller for energy-efficient lighting control
- DALI-2 certified product
- Integrated DALI power supply
- DALI interface for controlling digital, dimmable ECGs in broadcast mode
- Manual switching or dimming via conventional pushbuttons
- Bidirectional IR communication enables fast integration into the project management function of the B.E.G. One app
- Complete range of functions can only be activated using the BLE-IR-Adapter and a compatible Smartphone or Tablet (Android, iOS).
- Semi-automatic, full automatic, presence-independent or light-independent mode adjustable
- Intelligent regulation algorithm with extensive setting options
- Software is backwards compatible with the first generation (except DSI, double lock and corridor function)
- Factory setting 10 min follow-up time and 500 lux brightness set value
- Including pre-assembled spring clamp with strain relief and contact protection cap for recessed ceiling mounting
- Accessory for surface mounting available

① Walking across
 ② Walking towards
 ③ Seated activity

IP20 max. Ø 10 m across 230 V approx. 2 W

Description	Colour	Part number
PD2N-M-DACO DALI-2	white mat, similar to RAL9010	93452



LUXOMAT® PD4N-M-DACO DALI-2



- Occupancy detector with integrated DALI application controller for energy-efficient lighting control
- DALI-2 certified product
- Integrated DALI power supply
- DALI interface for controlling digital, dimmable ECGs in broadcast mode
- Manual switching or dimming via conventional pushbuttons
- Bidirectional IR communication enables fast integration into the project management function of the B.E.G. One app
- Complete range of functions can only be activated using the BLE-IR-Adapter and a compatible Smartphone or Tablet (Android, iOS).
- Semi-automatic, full automatic, presence-independent or light-independent mode adjustable
- Intelligent regulation algorithm with extensive setting options
- Software is backwards compatible with the first generation (except DSI, double lock and corridor function)
- Factory setting 10 min follow-up time and 500 lux brightness set value
- Including pre-assembled spring clamp with strain relief and contact protection cap for recessed ceiling mounting
- Accessory for surface mounting available
- Accessories for wall mounting optionally available
- Further accessories for colour matching optionally available

① Walking across
 ② Walking towards
 ③ Seated activity

IP20 max. Ø 24 m across 230 V approx. 2 W

Description	Colour	Part number
PD4N-M-DACO DALI-2	white mat, similar to RAL9010	93460

Occupancy detectors DALI Compact



LUXOMAT® PD4-M-DACO-GH-SM DALI-2



- Occupancy detector for large heights with integrated DALI application controller for energy-efficient lighting control
- External telescopic light sensor for a mounting height between 5 and 16 m (mechanically adjustable) for measuring the light according to the application.
- DALI-2 certified product
- Integrated DALI power supply
- DALI interface for controlling digital, dimmable ECGs in broadcast mode
- Manual switching or dimming via conventional pushbuttons
- Bidirectional IR communication enables fast integration into the project management function of the B.E.G. One app
- Complete range of functions can only be activated using the BLE-IR-Adapter and a compatible Smartphone or Tablet (Android, iOS).
- Semi-automatic, full automatic, presence-independent or light-independent mode adjustable
- Intelligent regulation algorithm with extensive setting options
- Software is backwards compatible with the first generation (except DSI, double lock and corridor function)
- Factory setting 10 min follow-up time and 500 lux brightness set value
- There are markings to ensure correct alignment during installation
- **When used in high-bay warehouses, care should be taken that, in the cross-aisles of the warehouse, detectors are installed that can detect movement only in the desired aisle locations, by using blinds or other technical arrangements.**
- Surface-mount version

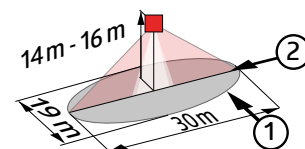

- ① Walking across
- ② Walking towards

IP54	30 m x 19 m	230 V	approx. 2 W

Description	Colour	Part number
PD4-M-DACO-GH-SM DALI-2	white mat, similar to RAL9010	93469



LUXOMAT® PD9N-M-DACO DALI-2



- Mini occupancy detector with integrated DALI application controller for energy-efficient lighting control
- DALI-2 certified product
- Integrated DALI power supply
- DALI interface for controlling digital, dimmable ECGs in broadcast mode
- Manual switching or dimming via conventional pushbuttons
- Bidirectional IR communication enables fast integration into the project management function of the B.E.G. One app
- Complete range of functions can only be activated using the BLE-IR-Adapter and a compatible Smartphone or Tablet (Android, iOS).
- Semi-automatic, full automatic, presence-independent or light-independent mode adjustable
- Intelligent regulation algorithm with extensive setting options
- Software is backwards compatible with the first generation (except DSI, double lock and corridor function)
- Factory setting 10 min follow-up time and 500 lux brightness set value
- Spring clips for quick and easy installation in suspended ceilings and light fittings
- Includes 45 mm cover ring and blinds
- Power supply passes through the hole in the ceiling for the detector (34 mm Ø)

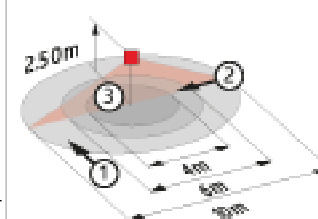

- ① Walking across
- ② Walking towards
- ③ Seated activity

IP20	max. Ø 10 m across	230 V	approx. 2 W

Description	Colour	Part number
PD9N-M-DACO DALI-2	white mat, similar to RAL9010	93470

Occupancy detectors DALI Compact



LUXOMAT® PD11-M-DACO-FLAT DALI-2



- Occupancy detector with integrated DALI application controller for energy-efficient lighting control
- DALI-2 certified product
- Integrated DALI power supply
- DALI interface for controlling digital, dimmable ECGs in broadcast mode
- Manual switching or dimming via conventional pushbuttons
- Bidirectional IR communication enables fast integration into the project management function of the B.E.G. One app
- Complete range of functions can only be activated using the BLE-IR-Adapter and a compatible Smartphone or Tablet (Android, iOS).
- Semi-automatic, full automatic, presence-independent or light-independent mode adjustable
- Intelligent regulation algorithm with extensive setting options
- Software is backwards compatible with the first generation (except DSI, double lock and corridor function)
- Factory setting 10 min follow-up time and 500 lux brightness set value
- Spring clips for quick and easy installation in suspended ceilings and light fittings
- Includes blinds and clamp ring for installation into light fittings
- Accessory for surface mounting available

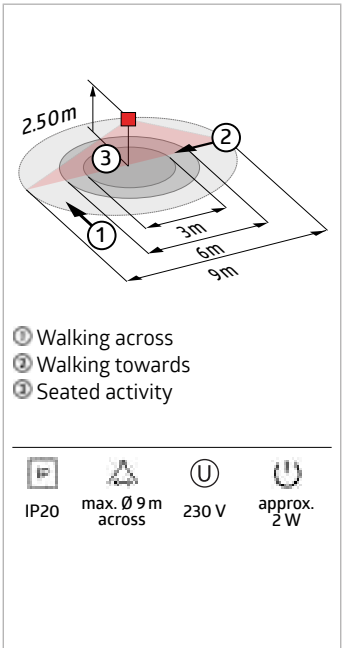

Description	Colour	Part number
PD11-M-DACO-FLAT DALI-2	white mat, similar to RAL9010	93459



LUXOMAT® PD2N-M-DACO-1C DALI-2



- Occupancy detector with integrated DALI application controller for energy-efficient lighting control
- DALI-2 certified product
- Integrated DALI power supply
- DALI interface for controlling digital, dimmable ECGs in broadcast mode
- Manual switching or dimming via conventional pushbuttons
- Bidirectional IR communication enables fast integration into the project management function of the B.E.G. One app
- Complete range of functions can only be activated using the BLE-IR-Adapter and a compatible Smartphone or Tablet (Android, iOS).
- Semi-automatic, full automatic, presence-independent or light-independent mode adjustable
- Powerful switching relay for different operating modes, e.g. Cut-off function for DALI ballasts, HVAC, blackboard illumination.
- Intelligent regulation algorithm with extensive setting options
- Software is backwards compatible with the first generation (except DSI, double lock and corridor function)
- Factory setting 10 min follow-up time and 500 lux brightness set value
- Including pre-assembled spring clamp with strain relief and contact protection cap for recessed ceiling mounting
- Accessory for surface mounting available

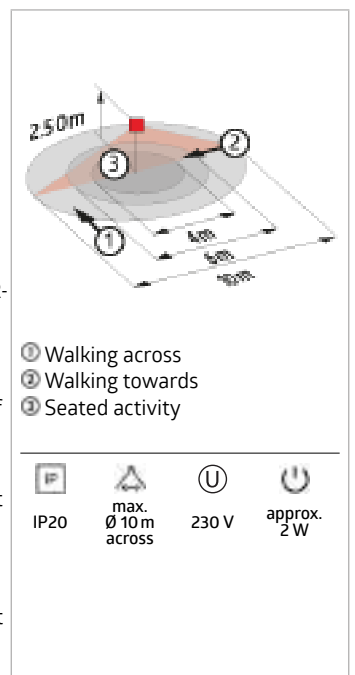

Description	Colour	Part number
PD2N-M-DACO-1C DALI-2	white mat, similar to RAL9010	93455

Occupancy detectors DALI Compact



LUXOMAT® PD4N-M-DACO-1C DALI-2



- Occupancy detector with integrated DALI application controller for energy-efficient lighting control
- DALI-2 certified product
- Integrated DALI power supply
- DALI interface for controlling digital, dimmable ECGs in broadcast mode
- Manual switching or dimming via conventional pushbuttons
- Bidirectional IR communication enables fast integration into the project management function of the B.E.G. One app
- Complete range of functions can only be activated using the BLE-IR-Adapter and a compatible Smartphone or Tablet (Android, iOS).
- Semi-automatic, full automatic, presence-independent or light-independent mode adjustable
- Powerful switching relay for different operating modes, e.g. Cut-off function for DALI ballasts, HVAC, blackboard illumination.
- Intelligent regulation algorithm with extensive setting options
- Software is backwards compatible with the first generation (except DSI, double lock and corridor function)
- Factory setting 10 min follow-up time and 500 lux brightness set value
- Including pre-assembled spring clamp with strain relief and contact protection cap for recessed ceiling mounting
- Accessory for surface mounting available
- Accessories for wall mounting optionally available
- Further accessories for colour matching optionally available



Description	Colour	Part number
PD4N-M-DACO-1C DALI-2	white mat, similar to RAL9010	93463

Occupancy detectors DALI Compact



LUXOMAT® PD4-M-DAA4G



- Flexible DALI Compact solution designed for conference rooms, training rooms and classrooms
- High-sensitivity occupancy detector with the capability to address up to 64 DALI electronic ballasts (EB) automatically, with segmented control via 4 groups
- Quick commissioning and maintenance processes via Smartphone/ Tablet App (Android, iOS) - No PC-Tool required
- 3 lighting zones:
A for main lighting with segmented constant light regulation via 3 DALI groups and offset control,
B for lectern or blackboard lighting via separate DALI group,
C for lectern or blackboard lighting by integrated relay
- Powerful switching relay for different operating modes, e.g. Cut-off function for DALI ballasts, HVAC, blackboard illumination.
- Manual switching or dimming via conventional pushbuttons
- Detection area can be extended with up to four Slave devices of type PD4-S-DAA4G
- Complete range of functions can only be activated using the B.E.G. IR Adapter or the BLE-IR-Adapter and a compatible Smartphone or Tablet (Android, iOS).
- External light sensor can be swivelled by 45°
- Avoidance of standby losses of the lighting system in accordance with EnEV DIN V 18599-4

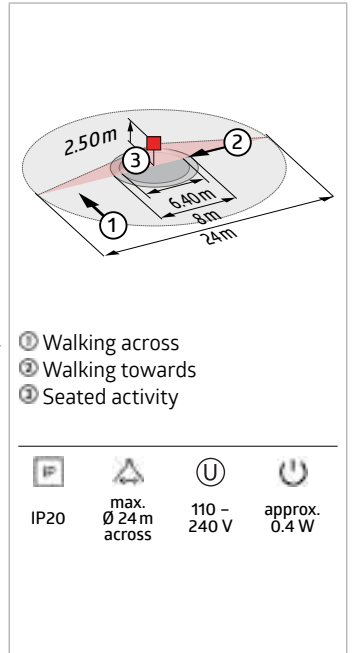

Description	Colour	Part number
PD4-M-DAA4G-FC	white mat, similar to RAL9010	92591
PD4-M-DAA4G-SM	white mat, similar to RAL9010	92743



LUXOMAT® PD4-S-DAA4G



- DALI bus operated slave device
- For extension of the detection area of a master device PD4-M-DAA4G / PD4-M-HCL
- Trigger pulse to master device upon detected movement independent of the ambient light level
- Automatic test mode via master device
- Plug & Play – no parameterisation required
- Easy to mount
- False ceiling or surface mount version available

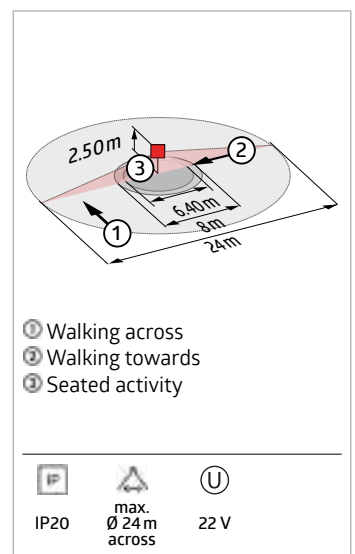

Description	Colour	Part number
PD4-S-DAA4G-FC	white mat, similar to RAL9010	92721
PD4-S-DAA4G-SM	white mat, similar to RAL9010	92759



LUXOMAT[®]net PD11-DALI-LINK-FLAT



- Low profile DALI multisensor (visible height: 0,85 mm)
- Powered via DALI bus
- Seamless integration in DALI lighting control system B.E.G. LUXOMAT[®]net DALI-LINK as modular multimaster option
- Detection area can be extended thanks to master-slave-mode
- Measuring of mixed light thanks to internal light sensor
- Semi-automatic, full-automatic or twilight switch mode
- Integrated daylight harvesting circuit (or switch output)
- Guided Light, Soft-Start PLUS, Orientation light PLUS
- Works out-of-the box for easy installation check
- Full range of functions can only be activated with other products of the product group B.E.G. LUXOMAT[®]net DALI-LINK
- Spring clips for quick and easy installation in suspended ceilings
- Includes blinds and clamp ring for installation into light fittings
- Flush mounting with accessory 92833, surface mounting with accessories 92833 and 92121

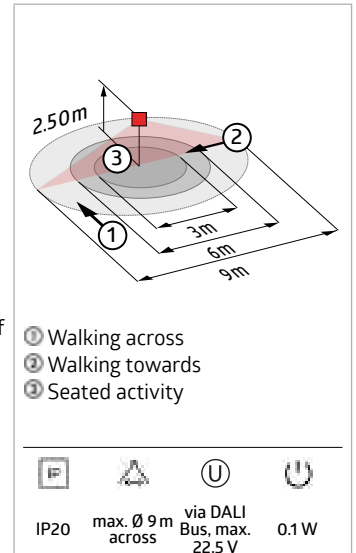

Description	Colour	Part number
PD11-DALI-LINK-FLAT-FC	white mat, similar to RAL9010	93068

LUXOMAT[®]net PD4N-DALI-LINK



- Wide motion detection range DALI multisensor
- Powered via DALI bus
- Seamless integration in DALI lighting control system B.E.G. LUXOMAT[®]net DALI-LINK as modular multimaster option
- Detection area can be extended thanks to master-slave-mode
- Mixed light measurement with internal and external light sensor
- Semi-automatic, full-automatic or twilight switch mode
- Integrated daylight harvesting circuit (or switch output)
- Guided Light, Soft-Start PLUS, Orientation light PLUS
- Works out-of-the box for easy installation check
- Full range of functions can only be activated with other products of the product group B.E.G. LUXOMAT[®]net DALI-LINK
- Detection area can be restricted with blinds

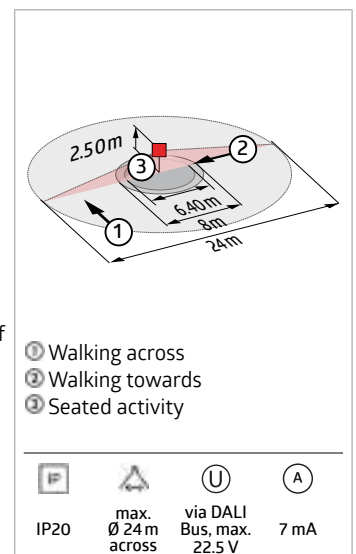

Description	Colour	Part number
PD4N-DALI-LINK	white mat, similar to RAL9010	93377



LUXOMAT®net PD4-DALI-LINK-GH



- DALI multisensor for surface mounting in large mounting heights
- Powered via DALI bus
- External telescopic light sensor for a mounting height between 5 and 16 m (mechanically adjustable) for measuring the light according to the application.
- Bright LED indication for commissioning
- Designed as multimaster device
- Logical switching or control output
- Guided Light, Soft-Start PLUS, Orientation light PLUS
- Works out-of-the box for easy installation check
- Seamless integration in DALI lighting control system B.E.G. LUXOMAT®net DALI-LINK as modular multimaster option
- Full range of functions can only be activated with other products of the product group B.E.G. LUXOMAT®net DALI-LINK
- **When used in high-bay warehouses, care should be taken that, in the cross-aisles of the warehouse, detectors are installed that can detect movement only in the desired aisle locations, by using blinds or other technical arrangements.**

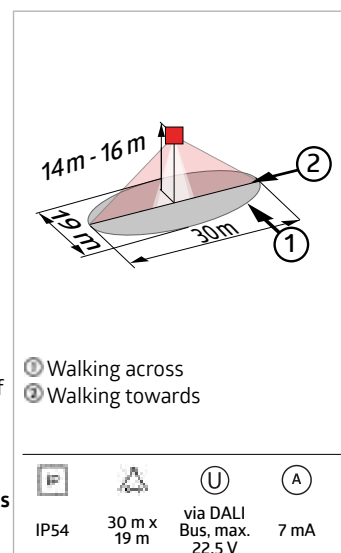

Description	Colour	Part number
PD4-DALI-LINK-GH-SM	white mat	93845



LUXOMAT®net PICO-DALI-LINK



- Mini DALI multisensor with only 11mm installation depth for installation in luminaires
- Powered via DALI bus
- Seamless integration in DALI lighting control system B.E.G. LUXOMAT®net DALI-LINK as modular multimaster option
- Detection area can be extended thanks to master-slave-mode
- Measuring of mixed light thanks to internal light sensor
- Semi-automatic, full-automatic or twilight switch mode
- Integrated daylight harvesting circuit (or switch output)
- Guided Light, Soft-Start PLUS, Orientation light PLUS
- Works out-of-the box for easy installation check
- Full range of functions can only be activated with other products of the product group B.E.G. LUXOMAT®net DALI-LINK
- Detection area can be restricted with blinds

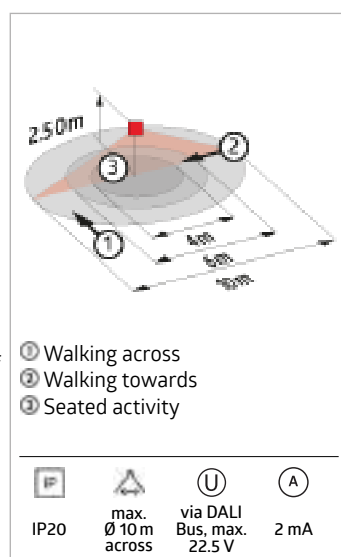

Description	Colour	Part number
PICO-DALI-LINK-FC	white, similar to RAL9010	93908



LUXOMAT[®]net PBM-DALI-LINK-4W-BLE



- DALI pushbutton module with 4 binary inputs and integrated Bluetooth gateway for hidden mounting behind flush mount switches.
- Parameterisation of the DALI-LINK solution via Bluetooth with a smartphone and the B.E.G. DALI-LINK App.
- 4 inputs for conventional push buttons, freely configurable
- Operating modes: Standard, staircase or scene mode
- Integrated buzzer to determine location of installed device
- Full range of functions can only be activated with other products of the product group B.E.G. LUXOMAT[®]net DALI-LINK

 IP20	 via DALI Bus, max. 22.5 V	 7 mA
----------	-------------------------------------	----------

Description	Colour	Part number
PBM-DALI-LINK-4W-BLE	-	92732



LUXOMAT[®]net PBM-DALI-LINK-4W



- Binary DALI input device for installation in in-wall sockets
- 4 inputs for conventional push buttons, freely configurable
- Operating modes: Standard, staircase or scene mode
- Integrated LED to determine location of dismantled device
- Integrated buzzer to determine location of installed device
- DIP- and HEX-switch for quick commissioning with basic functionality
- Full range of functions can only be activated with other products of the product group B.E.G. LUXOMAT[®]net DALI-LINK

 via DALI Bus, max. 22 V	 7 mA
-----------------------------------	----------

Description	Colour	Part number
PBM-DALI-LINK-4W	white	93396



LUXOMAT®net PS-DALI-LINK-FC



- DALI power supply for the B.E.G. DALI-LINK multi room solution for installation in suspended ceilings.
- Parameterisation of the DALI-LINK solution via Bluetooth with a smartphone and the B.E.G. DALI-LINK App.
- For example, 25 DALI luminaires and 6 DALI-LINK control devices (multi-sensors or push-button interfaces) can be connected to the power supply.
- It is possible to operate a maximum of one additional DALI-LINK power supply in parallel, doubling the number of DALI devices in the DALI-LINK system (50 DALI luminaires / 12 DALI-LINK control units).
- Integrated temperature monitoring and short-circuit detection
- Integrated LED for visualisation of operating information
- DALI-2 certified product

IP20	110 – 277 V	3.3 W

Description	Colour	Part number
PS-DALI-LINK-FC	white	92846

LUXOMAT®net PS-DALI-LINK-USB-REG



- DALI power supply with integrated USB interface for DIN-rail mounting
- For example, 45 DALI luminaires and 10 DALI-LINK control devices (multi-sensors or push-button interfaces) can be connected to the power supply.
- Integrated USB interface allows expansion to networkable B.E.G. LUXOMAT®net DALI-SYS lighting management solution
- Integrated LEDs for visualisation of operating information
- Commissioning of the B.E.G. LUXOMAT®net DALI-LINK solution takes place via a free app and the PBM-DALI-LINK-4W-BLE push-button module

IP20	230 V	6 W

Description	Colour	Part number
PS-DALI-LINK-USB-REG	white	93189



LUXOMAT®net SW-DALI-LINK-BLE-APP



- Smartphone App for commissioning and/or operating the B.E.G. LUXOMATnet DALI-LINK multi room lighting control solution
- 2 software versions for iOS and Android
- Available for free in the corresponding app store (search for „B.E.G. DALI-LINK“)
- App uses Bluetooth technology
- QR-Code authorisation mechanism for commissioning process
- Create and edit up to 16 scenes
- Quick localisation of DALI devices with grouping wizard
- Supports addressing and parameterisation of B.E.G. DALI-LINK multi-sensors, B.E.G. DALI-LINK push button modules, B.E.G. DALI-LINK relay modules and DALI control gear of any manufacturer
- All device parameters can be copied and pasted to other devices
- Multi-lingual user interface

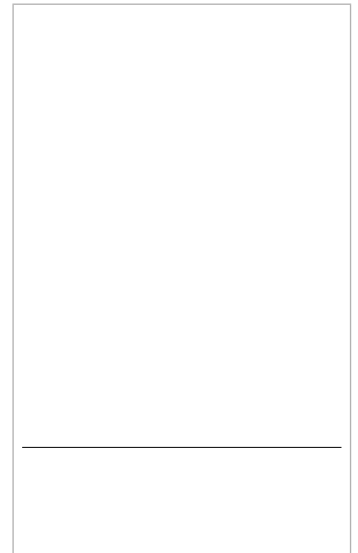

Description	Colour	Part number
SW-DALI-LINK-BLE-APP		92847





DALI-LINK



LUXOMAT[®]net RM-DALI-LINK-1C-REG



- DIN-rail DALI relay module with 1 switching channel
- High-output and potential-free contact for loads with high inrush current
- Integrated application controller with different operating modes
- Operating modes: Standard, Cut-off, HVAC, Impulse, Alarm
- DIP- and HEX-switch for quick commissioning with basic functionality
- Full range of functions can only be activated with other products of the product group B.E.G. LUXOMAT[®]net DALI-LINK

			
3000 W	IP20	via DALI Bus, max. 22.5 V	10 mA

Description	Colour	Part number
RM-DALI-LINK-1C-REG	white	93807



LUXOMAT[®]net RM-DALI-LINK-4C-REG



- Switching actuator for switching loads
- Integrated application controller with different operating modes
- Operating modes: Standard, Cut-off, HVAC, Impulse, Alarm
- Full range of functions can only be activated with other products of the product group B.E.G. LUXOMAT[®]net DALI-LINK

			
3000 W	IP20	230 V	10 mA

Description	Colour	Part number
RM-DALI-LINK-4C-REG	white	93854



LUXOMAT®net PD4-CAS-GH



- Casambi occupancy detector for surface mounting in large mounting heights
- Bright LED indication for commissioning
- External telescopic light sensor for a mounting height between 5 and 16 m (mechanically adjustable) for measuring the light according to the application.
- Mixed light measurement with external light sensor
- Adjustment of the reflection factor and input of the luminosity for the display of the actual luminosity in the app
- Extension of the detection area with additional B.E.G. Casambi devices possible
- Individual adaption of detection sensitivity for each PIR sensor
- Detection area can be restricted with blinds
- There are markings to ensure correct alignment during installation
- **When used in high-bay warehouses, care should be taken that, in the cross-aisles of the warehouse, detectors are installed that can detect movement only in the desired aisle locations, by using blinds or other technical arrangements.**
- Manual switching and dimming via push button possible
- Functions adjustable via Casambi app

① Walking across
② Walking towards

IP54 30 m x 19 m 230 V 0.4 W

Description	Colour	Part number
PD4-CAS-GH	white mat, similar to RAL9010	93472



LUXOMAT®net PD4-CAS-GH DALI-2



- Casambi occupancy detector for surface mounting in large mounting heights
- Integrated DALI power supply
- DALI-2 interface for controlling digital, dimmable ECGs in broadcast mode
- DALI-2 certified product
- Integrated temperature monitoring and short-circuit detection
- Bright LED indication for commissioning
- External telescopic light sensor for a mounting height between 5 and 16 m (mechanically adjustable) for measuring the light according to the application.
- Mixed light measurement with external light sensor
- Adjustment of the reflection factor and input of the luminosity for the display of the actual luminosity in the app
- Extension of the detection area with additional B.E.G. Casambi devices possible
- Individual adaption of detection sensitivity for each PIR sensor
- Detection area can be restricted with blinds
- There are markings to ensure correct alignment during installation
- **When used in high-bay warehouses, care should be taken that, in the cross-aisles of the warehouse, detectors are installed that can detect movement only in the desired aisle locations, by using blinds or other technical arrangements.**
- Manual switching and dimming via push button possible
- Functions adjustable via Casambi app

① Walking across
② Walking towards

IP54 30 m x 19 m 230 V 0.4 W

Description	Colour	Part number
PD4-CAS-GH DALI-2	white mat, similar to RAL9010	93471

B.E.G. LUXOMAT[®] net



DALI-SYS – The building solution

- Networkable, modular multimaster concept
- Combines lighting management, emergency luminaire management, shutter/blind control and HVAC functions on one platform
- Decentralised control with distributed intelligence to provide high operational reliability
- B.E.G. multisensors have no power supply unit and are powered via the DALI bus
- Visualisation and central functions possible without higher-level BMS
- BMS connection via BACnet possible
- Planning, commissioning and maintenance by B.E.G.
- Cross-trade and cross-protocol logic links possible with NETx Automation

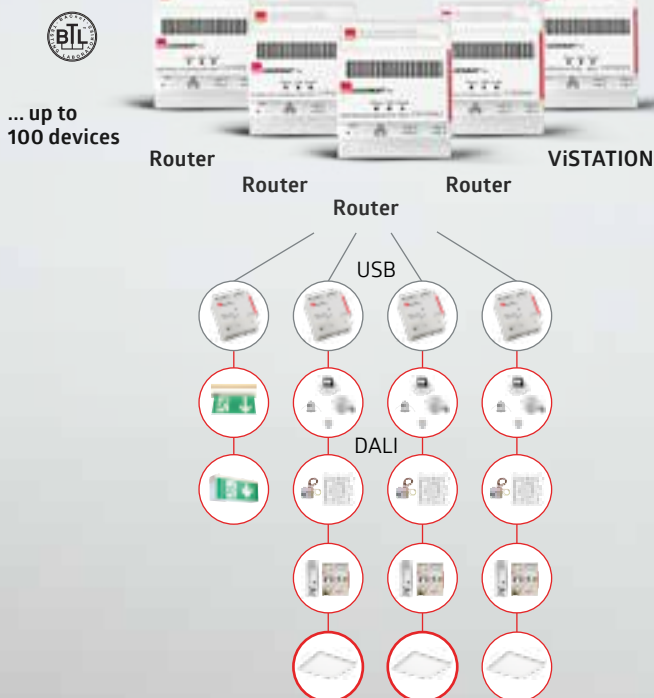

B.E.G. LUXOMAT® net



Energy efficiency and comfort in buildings - with KNX solutions from B.E.G..

The plus of well-being for every building user

Pleasant room climate, automated lighting - intelligent building control should aim to ensure that we can always move comfortably in buildings: Security and a feel-good atmosphere without the daily operation by humans. Buildings become intelligent and take on numerous tasks. The entire building system technology thus functions as a silent servant. This is the highest form of comfort.

Particularly in functional buildings, bus technology offers cost advantages over conventional electrical installations, even during the electrical installation phase. In continuous operation, high energy savings can be achieved.

With KNX, you are choosing a globally established bus system that was developed specifically for the requirements of building installation. The range of functions is already enormous today and is growing in a future-proof manner in line with customer requirements.

With the current KNX Generation 7, KNX-operated buildings become particularly secure against unauthorised access. „KNX IP Secure“ ensures that all transmitted telegrams and data are fully encrypted. „KNX Data Secure“ effectively protects user data from manipulation through encryption and authentication.

From now on, lighting can be provided with KNX-certified products within the RGB colour palette. This makes it possible to implement individual building lighting in terms of colour. In addition, natural lighting conditions can be realised with the help of the detectors.

Discover what B.E.G. has to offer.





LUXOMAT® net PD2N-KNXs-OCCULOG-DX



- KNX occupancy detector with integrated KNX bus connector
- Low installation depth
- 1 x light output (for regulating or switching), 1 x slave output, 3 x HVAC outputs (separately programmable)
- Intelligent semi-automatic mode, occupancy-independent regulating mode (photoelectric switch), full automatic mode
- Two logic modules
- Individual adaption of the PIR sensor sensitivity
- Mixed light measurement with internal and external light sensor
- Various locking functions
- Status LEDs can be activated / deactivated
- Programming button (phys. address) can be operated via remote control
- Regulation of up to three lighting groups using offset (external influence possible)
- Short presence, self-adjusting follow-up time, corridor function
- Recall of light scenes
- Temperature- and noise sensor
- Measurement of air quality based on volatile organic compounds (VOC)
- Up to 4 limit values possible
- Measurement of relative air humidity
- Up to 4 limit values possible
- All values can be sent to the bus and used for HVAC applications
- Controller for temperature, air quality and humidity
- Spring-clamps
- Blinds

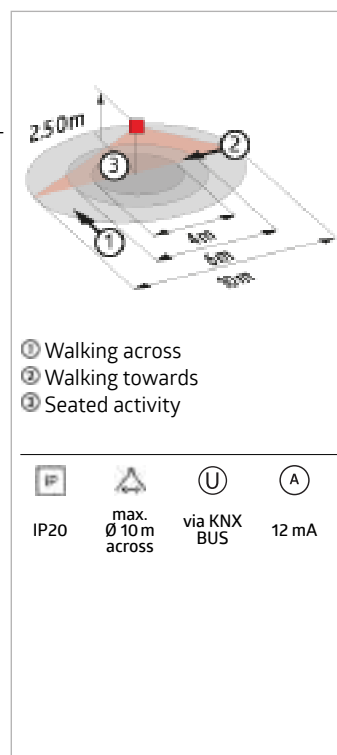

Description	Colour	Part number
PD2N-KNXs-OCCULOG-DX-FC	white mat, similar to RAL9010	93530
PD2N-KNXs-OCCULOG-DX-FM	white mat, similar to RAL9010	93531



LUXOMAT® net PD2N-KNXs-DX



- KNX occupancy detector with integrated KNX bus connector
- KNX Secure ready
- HCL/RGB control
- Parameterisation from ETS 5 for integration into KNX systems
- Individual adaption of the PIR sensor sensitivity
- Mixed light measurement using internal, external and remote (optional) light sensors
- Intelligent semi-automatic mode, occupancy-independent regulating mode (photoelectric switch), full automatic mode
- 1 x light output (for regulating or switching), 1 x slave output, 3 x HVAC outputs (separately programmable)
- Regulation of up to three lighting groups using offset (external influence possible)
- Short presence, self-adjusting follow-up time, corridor function
- Various locking functions
- Soft-start
- Two logic modules
- Recall of light scenes
- Deactivatable status indicators
- Temperature- and noise sensor

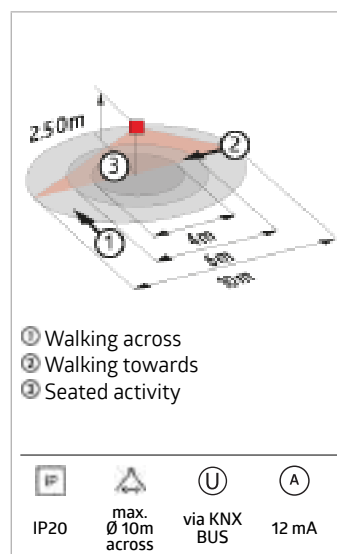

Description	Colour	Part number
PD2N-KNXs-DX-FC	white mat, similar to RAL9010	93512
PD2N-KNXs-DX-FM	white mat, similar to RAL9010	93513



LUXOMAT®net PD4N-KNXs-DX



- KNX occupancy detector with integrated KNX bus connector
- KNX Secure ready
- HCL/RGB control
- Parameterisation from ETS 5 for integration into KNX systems
- Individual adaption of detection sensitivity for each PIR sensor
- PIR sensors can be deactivated individually
- Direction of movement can be identified
- Mixed light measurement using internal, external and remote (optional) light sensors
- Intelligent semi-automatic mode, occupancy-independent regulating mode (photoelectric switch), full automatic mode
- 1 x light output (for regulating or switching), 1 x slave output, 3 x HVAC outputs (separately programmable)
- Regulation of up to three lighting groups using offset (external influence possible)
- Short presence, self-adjusting follow-up time, corridor function
- Various locking functions
- Soft-start
- Two logic modules
- Recall of light scenes
- Deactivatable status indicators
- Temperature- and noise sensor

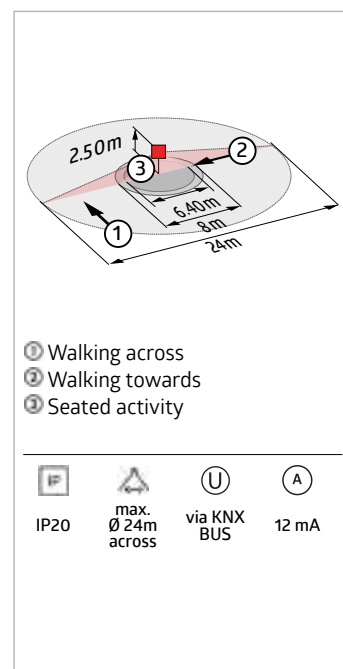

Description	Colour	Part number
PD4N-KNXs-DX-FC	white mat, similar to RAL9010	93516
PD4N-KNXs-DX-FM	white mat, similar to RAL9010	93517



LUXOMAT®net PD11-KNXs-FLAT-DX



- Low profile KNX occupancy detector with integrated KNX bus connector
- KNX Secure ready
- HCL/RGB control
- Parameterisation from ETS 5 for integration into KNX systems
- Individual adaption of the PIR sensor sensitivity
- Mixed light measurement using internal and remote (optional) light sensors
- Intelligent semi-automatic mode, occupancy-independent regulating mode (photoelectric switch), full automatic mode
- 1 x light output (for regulating or switching), 1 x slave output, 3 x HVAC outputs (separately programmable)
- Regulation of up to three lighting groups using offset (external influence possible)
- Short presence, self-adjusting follow-up time, corridor function
- Various locking functions
- Soft-start
- Two logic modules
- Recall of light scenes
- Deactivatable status indicators
- Temperature- and noise sensor
- Flush mounting with accessory 92833, surface mounting with accessories 92833 and 92121

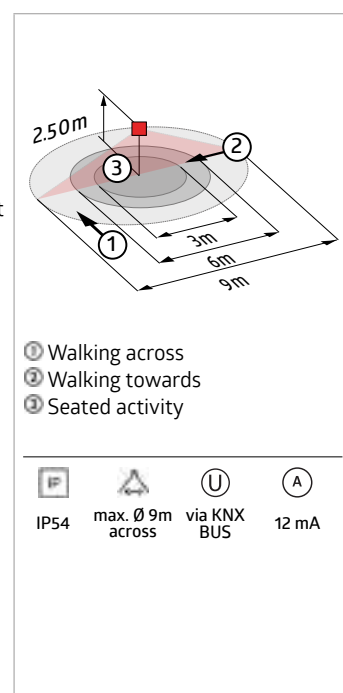

Description	Colour	Part number
PD11-KNXs-FLAT-DX-FC	white mat, similar to RAL9010	93523



LUXOMAT®net PD9-KNXs-DX



- KNX mini occupancy detector with integrated bus connector
- KNX Secure ready
- HCL/RGB control
- Parameterisation from ETS 5 for integration into KNX systems
- Individual adaption of the PIR sensor sensitivity
- Mixed light measurement using internal and remote (optional) light sensors
- Intelligent semi-automatic mode, occupancy-independent regulating mode (photoelectric switch), full automatic mode
- 1 x light output (for regulating or switching), 1 x slave output, 3 x HVAC outputs (separately programmable)
- Regulation of up to three lighting groups using offset (external influence possible)
- Short presence, self-adjusting follow-up time, corridor function
- Various locking functions
- Soft-start
- Two logic modules
- Recall of light scenes
- Deactivatable status indicators

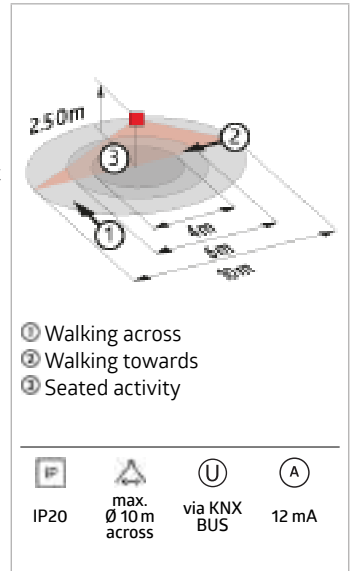

Description	Colour	Part number
PD9-KNXs-DX-FC	white mat, similar to RAL9010	93520

LUXOMAT®net PD9-KNXs-GH-DX



- KNX mini occupancy detector with integrated KNX bus connector, especially for large mounting heights
- KNX Secure ready
- HCL/RGB control
- Parameterisation from ETS 5 for integration into KNX systems
- Individual adaption of the PIR sensor sensitivity
- Mixed light measurement using internal and remote (optional) light sensors
- Intelligent semi-automatic mode, occupancy-independent regulating mode (photoelectric switch), full automatic mode
- 1 x light output (for regulating or switching), 1 x slave output, 3 x HVAC outputs (separately programmable)
- Regulation of up to three lighting groups using offset (external influence possible)
- Short presence, self-adjusting follow-up time, corridor function
- Various locking functions
- Soft-start
- Two logic modules
- Recall of light scenes
- Deactivatable status indicators

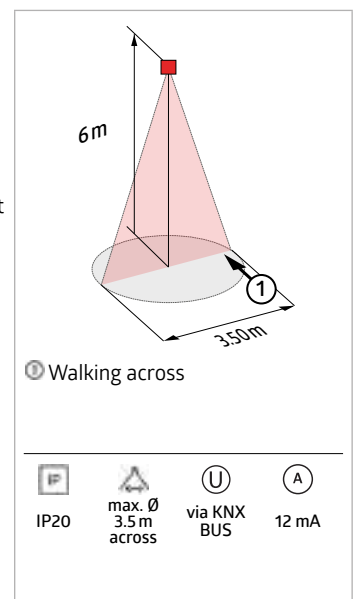

Description	Colour	Part number
PD9-KNXs-GH-DX-FC	white mat, similar to RAL9010	93521



LUXOMAT[®]net PD4N-KNXs-GH-DX



- KNX occupancy detector designed for high-bay warehouses, with integrated KNX bus connector
- KNX Secure ready
- HCL/RGB control
- Parameterisation from ETS 5 for integration into KNX systems
- Individual adaption of detection sensitivity for each PIR sensor
- PIR sensors can be deactivated individually
- Direction of movement can be identified
- External telescopic light sensor for a mounting height between 5 and 16 m (mechanically adjustable) for measuring the light according to the application.
- Mixed light measurement with internal and external light sensor
- Intelligent semi-automatic mode, occupancy-independent regulating mode (photoelectric switch), full automatic mode
- 1 x light output (for regulating or switching), 1 x slave output, 3 x HVAC outputs (separately programmable)
- Regulation of up to three lighting groups using offset (external influence possible)
- Short presence, self-adjusting follow-up time, corridor function
- Various locking functions
- Soft-start
- Two logic modules
- Recall of light scenes
- Deactivatable status indicators

① Walking across
② Walking towards

IP54	30 m x 19 m	via KNX BUS	12 mA

Description	Colour	Part number
PD4N-KNXs-GH-DX-SM	white mat, similar to RAL9010	93518



LUXOMAT[®]net Indoor 140-L-KNXs-DX



- KNX occupancy detector with integrated KNX bus coupler, especially for installation in walls
- KNX Secure ready
- Integrated downlight with the function of an orientation or a night light
- Integrated pushbutton (two functions programmable)
- HCL/RGB control
- Parameterisation from ETS 5 for integration into KNX systems
- Individual adaption of the PIR sensor sensitivity
- Mixed light measurement using internal and remote (optional) light sensors
- Intelligent semi-automatic mode, occupancy-independent regulating mode (photoelectric switch), full automatic mode
- 1 x light output (for regulating or switching), 1 x slave output, 3 x HVAC outputs (separately programmable)
- Regulation of up to three lighting groups using offset (external influence possible)
- Short presence, self-adjusting follow-up time, corridor function
- Various locking functions
- Soft-start
- Two logic modules
- Recall of light scenes
- Deactivatable status indicators

① Walking across
② Walking towards

IP20	max. 8 m across	via KNX BUS	24 mA

Description	Colour	Part number
Indoor 140-L-KNXs-DX covering not included	-	93526

LUXOMAT®net PICO-KNXs-DX



- KNX mini occupancy detector with integrated bus connector
- KNX Secure ready
- HCL/RGB control
- Parameterisation from ETS 5 for integration into KNX systems
- Individual adaption of the PIR sensor sensitivity
- Mixed light measurement using internal and remote (optional) light sensors
- Intelligent semi-automatic mode, occupancy-independent regulating mode (photoelectric switch), full automatic mode
- 1 x light output (for regulating or switching), 1 x slave output, 3 x HVAC outputs (separately programmable)
- Regulation of up to three lighting groups using offset (external influence possible)
- Short presence, self-adjusting follow-up time, corridor function
- Various locking functions
- Soft-start
- Two logic modules
- Recall of light scenes
- Deactivatable status indicators

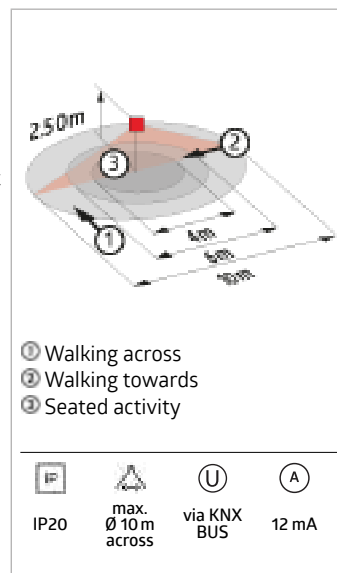

Description	Colour	Part number
PICO-KNXs-DX-FC	white mat, similar to RAL9010	93529

LUXOMAT®net RC-plus next N 230 KNXs-DX 230



- KNX occupancy detector with integrated KNX bus connector
- KNX Secure ready
- Integrated downlight with orientation or a night light (RGB) function
- HCL/RGB control
- Parameterisation from ETS 5 for integration into KNX systems
- Individual adaption of detection sensitivity for each PIR sensor
- PIR sensors can be deactivated individually
- Direction of movement can be identified
- Mixed light measurement using internal and remote (optional) light sensors
- Intelligent semi-automatic mode, occupancy-independent regulating mode (photoelectric switch), full automatic mode
- 1 x light output (for regulating or switching), 1 x slave output, 3 x HVAC outputs (separately programmable)
- Regulation of up to three lighting groups using offset (external influence possible)
- Short presence, self-adjusting follow-up time, corridor function
- Various locking functions
- Soft-start
- Two logic modules
- Recall of light scenes
- Deactivatable status indicators

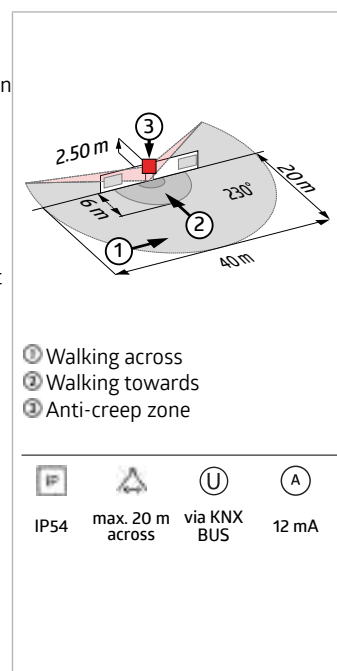

Description	Colour	Part number
RC-plus next N 230 KNXs-DX 230	white, similar to RAL9010	93527
RC-plus next N 230 KNXs-DX 230	black, similar to RAL9005	93528



LUXOMAT[®]net PD2N-KNXs-ST



- KNX occupancy detector with integrated KNX bus connector
- KNX Secure ready
- Parameterisation from ETS 5 for integration into KNX systems
- Individual adaption of the PIR sensor sensitivity
- Mixed light measurement using internal, external and remote (optional) light sensors
- Intelligent semi-automatic mode, occupancy-independent regulating mode (photoelectric switch), full automatic mode
- 1 x light output (for regulating or switching), 1 x slave output, 3 x HVAC outputs (separately programmable)
- Regulation of up to three lighting groups using offset (external influence possible)
- Short presence, self-adjusting follow-up time, corridor function
- Various locking functions
- Soft-start
- Recall of light scenes
- Deactivatable status indicators

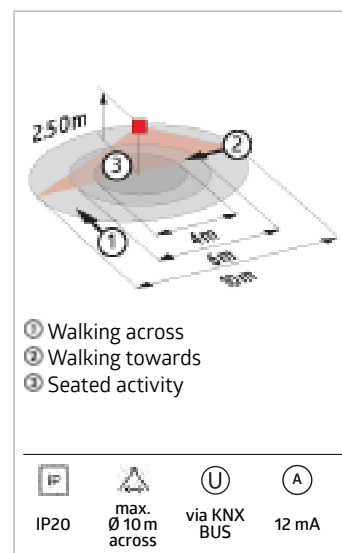

Description	Colour	Part number
PD2N-KNXs-ST-FC	white mat, similar to RAL9010	93510
PD2N-KNXs-ST-FM	white mat, similar to RAL9010	93511

LUXOMAT[®]net PD4N-KNXs-ST



- KNX occupancy detector with integrated KNX bus connector
- KNX Secure ready
- Parameterisation from ETS 5 for integration into KNX systems
- Individual adaption of detection sensitivity for each PIR sensor
- PIR sensors can be deactivated individually
- Direction of movement can be identified
- Mixed light measurement using internal, external and remote (optional) light sensors
- Intelligent semi-automatic mode, occupancy-independent regulating mode (photoelectric switch), full automatic mode
- 1 x light output (for regulating or switching), 1 x slave output, 3 x HVAC outputs (separately programmable)
- Regulation of up to three lighting groups using offset (external influence possible)
- Short presence, self-adjusting follow-up time, corridor function
- Various locking functions
- Soft-start
- Recall of light scenes
- Deactivatable status indicators

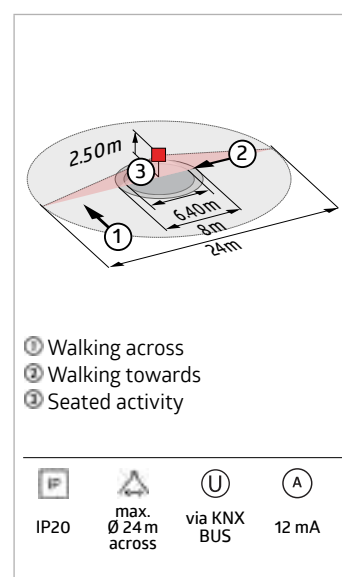

Description	Colour	Part number
PD4N-KNXs-ST-FC	white mat, similar to RAL9010	93514
PD4N-KNXs-ST-FM	white mat, similar to RAL9010	93515



LUXOMAT®net PD11-KNXs-FLAT-ST



- Low profile KNX occupancy detector with integrated KNX bus connector
- KNX Secure ready
- Parameterisation from ETS 5 for integration into KNX systems
- Individual adaption of the PIR sensor sensitivity
- Mixed light measurement using internal and remote (optional) light sensors
- Intelligent semi-automatic mode, occupancy-independent regulating mode (photoelectric switch), full automatic mode
- 1 x light output (for regulating or switching), 1 x slave output, 3 x HVAC outputs (separately programmable)
- Regulation of up to three lighting groups using offset (external influence possible)
- Short presence, self-adjusting follow-up time, corridor function
- Various locking functions
- Soft-start
- Recall of light scenes
- Deactivatable status indicators
- Flush mounting with accessory 92833, surface mounting with accessories 92833 and 92121

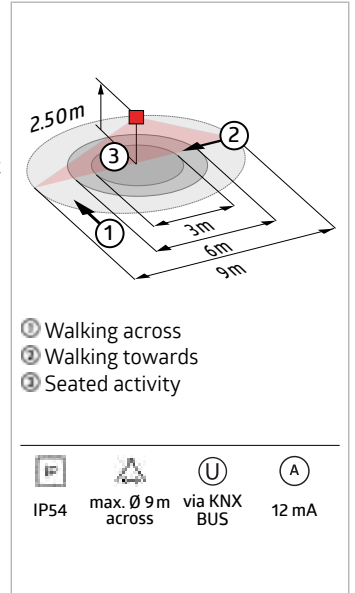

Description	Colour	Part number
PD11-KNXs-FLAT-ST-FC	white mat, similar to RAL9010	93522



LUXOMAT®net Indoor 180-KNXs-ST



- KNX occupancy detector with integrated KNX bus coupler, especially for installation in walls
- KNX Secure ready
- Parameterisation from ETS 5 for integration into KNX systems
- Individual adaption of the PIR sensor sensitivity
- Mixed light measurement using internal and remote (optional) light sensors
- Intelligent semi-automatic mode, occupancy-independent regulating mode (photoelectric switch), full automatic mode
- 1 x light output (for regulating or switching), 1 x slave output, 3 x HVAC outputs (separately programmable)
- Regulation of up to three lighting groups using offset (external influence possible)
- Short presence, self-adjusting follow-up time, corridor function
- Various locking functions
- Soft-start
- Recall of light scenes
- Deactivatable status indicators

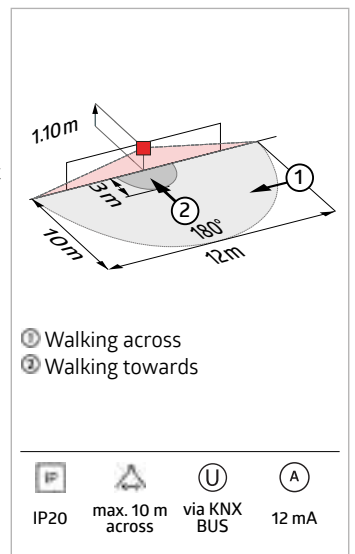

Description	Colour	Part number
Indoor 180-KNXs-ST covering not included	-	93524



LUXOMAT[®]net PICO-KNXs-ST



- KNX mini occupancy detector with integrated bus connector
- KNX Secure ready
- Parameterisation from ETS 5 for integration into KNX systems
- Individual adaptation of the PIR sensor sensitivity
- Mixed light measurement using internal and remote (optional) light sensors
- Intelligent semi-automatic mode, occupancy-independent regulating mode (photoelectric switch), full automatic mode
- 1 x light output (for regulating or switching), 1 x slave output, 3 x HVAC outputs (separately programmable)
- Regulation of up to three lighting groups using offset (external influence possible)
- Short presence, self-adjusting follow-up time, corridor function
- Various locking functions
- Soft-start
- Recall of light scenes
- Deactivatable status indicators

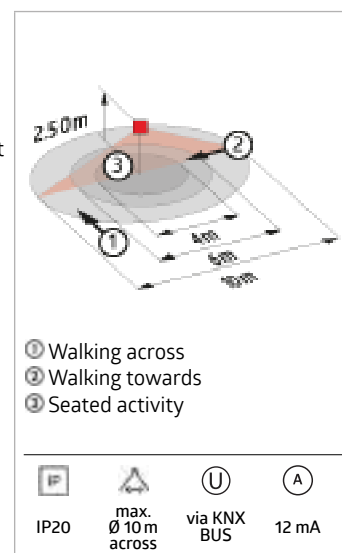

Description	Colour	Part number
PICO-KNXs-ST-FC	white mat, similar to RAL9010	93539

LUXOMAT[®]net ViSTATION-KNX REG



- Virtual Interface Station - The visualisation and remote server for KNX systems
- Plastic housing, 4 widths units (DIN-rail, top hat)
- 1 Ethernet/LAN connection
- 2D floor plan and/or tile view with customer-specific data
- Central visualisation of light, occupancy and error data
- Manual override of individual lighting zones possible
- Manual override via scene function possible
- User and rights management for individual control of specific rooms
- Can be operated via compatible web browser on any user device (smartphone, tablet, PC)
- Including separately enclosed 5VDC/2A power supply for DIN rail mounting (~18mm)
- Administration access preconfigured for user administration
- Weekly timer
- Astro program, e.g. for sunrise or sunset events



Description	Colour	Part number
ViSTATION-KNX REG	grey	93335

Intelligent building automation with KNX actuators from B.E.G.



Article number	Description	Function
90404	LAN-IF/KNXsREG	Programming interface as LAN data interface
93335	VISTATION-KNX REG	The visualisation and remote server for KNX systems
93182	SA8-230/10/H/KNXs-K REG	8-way switching actuator with a width of 72 mm
90136	SA4-230/16/H/-(EM) KNX REG	4-way and 8-way switching actuators with and without current measurement
90139	SA4-230/16/H/-(EM) KNX REG	
93336	SA8-230/16/H/-(EM) KNX REG	
93339	SA8-230/16/H/-(EM) KNX REG	
93980	DIM4-230/1-10V/16/H/KNX REG	Used for switching and dimming fluorescent lamps with 1-10V ECG. The voltage is applied to the ECG via the relays of the device. The luminaires are controlled via the 1-10V voltage. The 1-10V voltage is supplied by the ECGs.
90222	DIM4-230/UNI/250/H/KNX REG	Switching and dimming of incandescent lamps, HV halogen lamps, Tronic transformers with halogen lamps, dimmable inductive transformers with halogen or LED lamps, HV LED and compact fluorescent lamps
90223	LZ-230/UNI/420 REG	
93930	SBA4-230/10/H/KNX REG	4-way shutter/blind actuator for roller shutters and blinds
90401	LK-TP/KNX REG (Twisted-Pair)	Line coupler for connecting two KNX segments
90403	LK-IP/KNXsREG (IP Verbindung)	
90214	PSN-230/640/30/KNX REG	640 mA power supply for 64 KNX devices
90224	USB-IF/KNX REG	Programming interface as USB data interface
93302	DALI-KNX-Gateway	Interface for KNX and DALI lighting control
90406	BIP-4-KNX REG (passiv)	KNX binary inputs for controlling luminaires, blinds, etc.
90405	BIA-4-KNX REG (aktiv)	

Article short list

Art.Nr.	Product name	Prod.gr.	Page	Art.Nr.	Product name	Prod.gr.	Page
91008	LC-plus 280 white	1	7	93341	RC-plus next N 280 white	1	7
91018	LC-plus 280 brown	1	7	93343	RC-plus next N 280 black	1	7
91028	LC-plus 280 black	1	7	93344	RC-plus next N 280 brown	1	7
91048	LC-plus 280 silver	1	7	93346	RC-plus next N 230 silver	1	6
91101	LC-Click 140 white	1	9	93377	PD4N-DALI-LINK	24	33
91102	LC-Click 140 black	1	9	93396	PBM-DALI-LINK-4W white	24	35
91121	LC-Click 200 white	1	9	93452	PD2N-M-DACO DALI-2	24	28
91122	LC-Click 200 black	1	9	93455	PD2N-M-DACO-1C DALI-2	24	30
92144	PD4N-1C-SM	13	12	93459	PD11-M-DACO-FLAT DALI-2	24	30
92149	PD4N-1C-FC	13	12	93460	PD4N-M-DACO DALI-2	24	28
92184	PD3N-1C-FC Micro	13	11	93463	PD4N-M-DACO-1C DALI-2	24	31
92190	PD3N-1C-SM	13	11	93469	PD4-M-DACO-GH-SM DALI-2	24	29
92196	PD3N-1C-FC	13	11	93470	PD9N-M-DACO DALI-2	24	29
92198	PD3N-2C-FC	13	14	93471	PD4-CAS-GH DALI-2	48	39
92219	PD3N-1C-SM Micro	13	11	93472	PD4-CAS-GH	48	39
92245	PD4-M-1C-GH-SM	13	21	93510	PD2N-KNXs-ST-FC	23	47
92249	CdS-FC	10	18	93511	PD2N-KNXs-ST-FM	23	47
92270	PD4N-1C-C-SM	13	13	93512	PD2N-KNXs-DX-FC	23	42
92274	PD4N-1C-C-FC	13	13	93513	PD2N-KNXs-DX-FM	23	42
92365	CdS-R	10	18	93514	PD4N-KNXs-ST-FC	23	47
92367	CdS-T-SM	10	17	93515	PD4N-KNXs-ST-FM	23	47
92369	CdS-SM	10	17	93516	PD4N-KNXs-DX-FC	23	43
92550	PD2-M-1C-SM	13	20	93517	PD4N-KNXs-DX-FM	23	43
92565	PD2-M-1C-FC	13	20	93518	PD4N-KNXs-GH-DX-SM	23	45
92576	PD3N-1C-NO-PF-FC	13	12	93520	PD9-KNXs-DX-FC	23	44
92580	PD4-M-1C-SM	13	20	93521	PD9-KNXs-GH-DX-FC	23	44
92583	PD11-M-1C-FLAT-FC	13	23	93522	PD11-KNXs-FLAT-ST-FC	23	48
92585	PD4-M-1C-FC	13	20	93523	PD11-KNXs-FLAT-DX-FC	23	43
92591	PD4-M-DAA4G-FC	24	32	93524	Indoor 180-KNXs-ST covering not included	23	48
92610	Indoor 180-R UK covering included	1	25	93526	Indoor 140-L-KNXs-DX covering not included	23	45
92716	Indoor 180N-R/2W-UK covering included	1	25	93527	RC-plus next N 230 KNXs-DX 230 white	23	46
92721	PD4-S-DAA4G-FC	24	32	93528	RC-plus next N 230 KNXs-DX 230 black	23	46
92732	PBM-DALI-LINK-4W-BLE	24	35	93529	PICO-KNXs-DX-FC	23	46
92743	PD4-M-DAA4G-SM	24	32	93530	PD2N-KNXs-OCCULOG-DX-FC	23	42
92759	PD4-S-DAA4G-SM	24	32	93531	PD2N-KNXs-OCCULOG-DX-FM	23	42
92846	PS-DALI-LINK-FC white	24	36	93539	PICO-KNXs-ST-FC	23	49
92847	SW-DALI-LINK-BLE-APP	24	37	93563	OCCULOG-1C-FC	13	24
92900	PD9-M-1C-FC	13	21	93807	RM-DALI-LINK-1C-REG white	24	38
92902	PD9-1C-FC	13	13	93845	PD4-DALI-LINK-GH-SM	24	34
92912	PD9-M-1C-SDB-IP65-FC white	13	22	93854	RM-DALI-LINK-4C-REG white	39	38
92934	PD9-1C-GH-FC	13	14	93908	PICO-DALI-LINK-FC	24	34
92985	PD9-1C-12-48V-FC	13	15	94055	PD2N-M-1C-LED-FC	13	23
93041	LC-Click-N 140 UK 2.000 W white	1	8	94327	Indoor 140-L covering included	1	26
93042	LC-Click-N 200 UK 2.000 W white	1	8	96510	PD3-MIC-2C-FC	13	15
93061	LC-Click-N 140 UK 2.000 W black	1	8				
93062	LC-Click-N 200 UK 2.000 W black	1	8				
93068	PD11-DALI-LINK-FLAT-FC	24	33				
93159	PICO-N-M-1C-FC	13	22				
93189	PS-DALI-LINK-USB-REG white	24	36				
93321	RC-plus next N 130 white	1	6				
93323	RC-plus next N 130 black	1	6				
93324	RC-plus next N 130 brown	1	6				
93331	RC-plus next N 230 white	1	6				
93333	RC-plus next N 230 black	1	6				
93334	RC-plus next N 230 brown	1	6				
93335	VISTATION-KNX REG grey	18	49				



■ Branches and commercial agencies