

**B.E.G.****LUXOMAT®**

## PD4N-S

Prod.No. 93241 EAN: 4007529932412

- Voltage: 110 - 240 V AC 50 / 60 Hz
- Dimensions: Ø 106 x 92 mm
- Power consumption: approx. 0.2 W

### Order data

Designation	Colour	Art.No
PD4N-S	white	93241

### Accessories

Designation	Colour	Art.No
Wire basket BSK (Ø 200 x 90 mm)	white	92199
SM socle mounting set IP65 PD4N	white	93314
SM socle mounting set IP54 PD4N H	anthracite	93786
SM socle mounting set IP54 PD4N H	white	93465
SM socle mounting set IP54 PD4N H	black	93788
SM socle mounting set IP54 PD4N H	traffic white	93787
lens PD4N, Cover ring	anthracite	93731
lens PD4N, Cover ring	black	93733
lens PD4N, Cover ring	traffic white	93732
Corridor lens PD4N type A	white	93073
Wall holder PD2N/4N Typ A	traffic white	93702
Wall holder PD2N/4N Typ A	anthracite	93701

Wall holder PD2N/4N Typ A	white	93700
Wall holder PD2N/4N Typ A	black	93703
Wall holder PD2N/4N Typ A	white	93164

## Technical data

Voltage:	110 - 240 V AC 50 / 60 Hz
Dimensions:	Ø 106 x 92 mm
Power consumption:	approx. 0.2 W
Detection area:	horizontal 360° (Ceiling mounting) max. Ø 24 m across
Range:	max. Ø 8 m towards max. Ø 6.4 m seated
Monitored area (tangential movement):	450 m <sup>2</sup> / 2.5 m mounting height
Mounting height min./max./recommended:	2 m / 10 m / 2.5 m
Degree / class of protection:	IP20 / Class II
Impact strength:	IK04
Ambient temperature:	-25 °C to +50 °C
Housing:	polycarbonate, UV-resistant
Material color:	white mat
Pulse interval:	2 or 9 sec

## Product information

Slave device detector with extended detection area

For extending the detection area of a Master device

Trigger pulse to master device upon detected movement independent of the ambient light level

Compatible with 230 V devices. Concerning exceptions please see the respective master device.

### Application examples:

open-plan offices, conference rooms, classrooms/seminar rooms, staircases, small offices, sports halls/ storage rooms

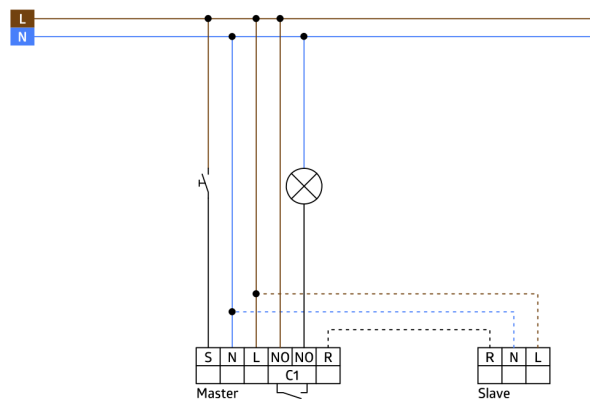
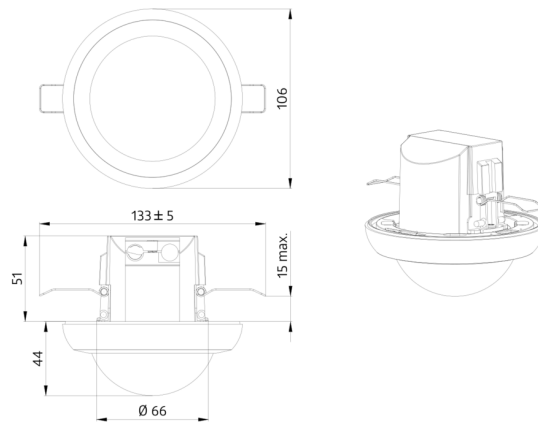

## Accessories

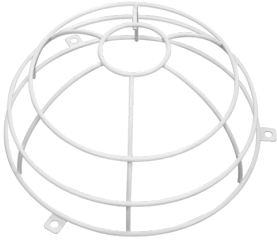

**Wire basket BSK (Ø 200 x 90 mm)**  
Art.No: 92199

Dimensions: Ø 200 x 90 mm  
Impact strength: IK09  
Housing: coated steel basket



**SM socle mounting set IP65 PD4N**  
Art.No: 93314

Dimensions: 133 x 133 x 69 mm  
Degree / class of protection: IP65  
Material color: white



**SM socle mounting set IP54 PD4N H**  
Art.No: 93786

Dimensions: Ø 110 x 45 mm  
Degree / class of protection: IP54  
Material color: anthracite, similar to RAL7016



**SM socle mounting set IP54 PD4N H**  
Art.No: 93465

Dimensions: Ø 110 x 45 mm  
Degree / class of protection: IP54  
Material color: white, similar to RAL9010



**SM socle mounting set IP54 PD4N H**  
Art.No: 93788

Dimensions: Ø 110 x 45 mm  
Degree / class of protection: IP54  
Material color: black, similar to RAL9005



**SM socle mounting set IP54 PD4N H**  
Art.No: 93787

Dimensions: Ø 110 x 45 mm  
Degree / class of protection: IP54  
Material color: traffic white, similar to RAL9016



**lens PD4N, Cover ring**  
Art.No: 93731

Detection area: horizontal 360°  
(Ceiling mounting)  
Range: max. &Oslash; 24 m  
across<br>max. &Oslash; 8 m  
towards<br>max. &Oslash; 6.4 m  
seated  
Monitored area (tangential  
movement): 450 m<sup>2</sup> / 2.5 m mounting  
height



**lens PD4N, Cover ring**  
Art.No: 93733

Detection area: horizontal 360°  
(Ceiling mounting)  
Range: max. &Oslash; 24 m  
across<br>max. &Oslash; 8 m  
towards<br>max. &Oslash; 6.4 m  
seated  
Monitored area (tangential  
movement): 450 m<sup>2</sup> / 2.5 m  
mounting height



**lens PD4N, Cover ring**  
Art.No: 93732

Detection area: horizontal 360°  
(Ceiling mounting)  
Range: max. &Oslash; 24 m  
across<br>max. &Oslash; 8 m  
towards<br>max. &Oslash; 6.4 m  
seated  
Monitored area (tangential  
movement): 450 m<sup>2</sup> / 2.5 m  
mounting height



**Corridor lens PD4N type A**

Art.No: 93073

Detection area: horizontal 360° (Ceiling mounting)  
Range: max. &Oslash; 40 m across<br>max. &Oslash; 20 m towards  
Monitored area (tangential movement): 250 m² / 2.5 m mounting height

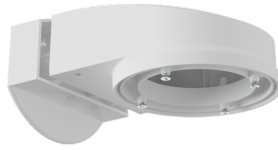

**Wall holder PD2N/4N Typ A**

Art.No: 93702

Dimensions: 133 x 106 x 66 mm  
Degree / class of protection: IP54 / Class II  
Housing: polycarbonate, UV-resistant

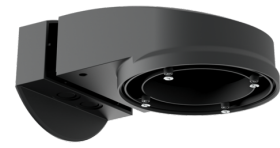

**Wall holder PD2N/4N Typ A**

Art.No: 93701

Dimensions: 133 x 106 x 66 mm  
Degree / class of protection: IP54 / Class II  
Housing: polycarbonate, UV-resistant

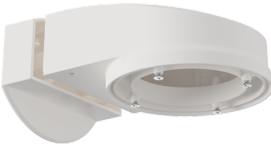

**Wall holder PD2N/4N Typ A**

Art.No: 93700

Dimensions: 133 x 106 x 66 mm  
Degree / class of protection: IP54 / Class II  
Housing: polycarbonate, UV-resistant

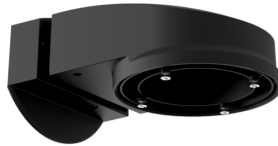

**Wall holder PD2N/4N Typ A**

Art.No: 93703

Dimensions: 133 x 106 x 66 mm  
Degree / class of protection: IP54 / Class II  
Housing: polycarbonate, UV-resistant



**Wall holder PD2N/4N Typ A**

Art.No: 93164

Dimensions: 133 x 106 x 66 mm  
Degree / class of protection: IP54 / Class II  
Housing: polycarbonate, UV-resistant