



ViSTATION

Individual visualisation for KNX



Individual ready-to-use visualisations for KNX

The B.E.G. ViSTATION for KNX offers a visualisation of the system that is as individual as the system itself. Using plans, graphics, photos or drawings, the KNX system integrator creates an individual solution for his customer. All luminaires, sensors and other relevant KNX components are positioned via drag-and-drop, and the end customer receives a ready-to-use visualisation that enables manual intervention in addition to informative display.

Uncomplicated operation

On small displays such as smartphones, the tile view is used; on larger displays, the user can alternatively use the floor plan view. All values used in the KNX system, such as temperature, brightness, open doors/windows, etc., can be viewed via the visualisation. In addition to ETS programming, time switching values can be specified for the system via the ViSTATION. In this way, easy programming is also possible for the end user.

Simple and clear

The platform-independent web interface allows any commercially available tablet with an appropriate mounting frame to be used as a cost-effective control panel. The user administration and the sophisticated distribution of rights are carried out centrally on the ViSTATION. This means that the end customer can create almost any number of users. It is also practical that the same authorisations only have to be created once and can then be automatically assigned to the users belonging to the group. This makes operation easy and clear for daily use.



System structure

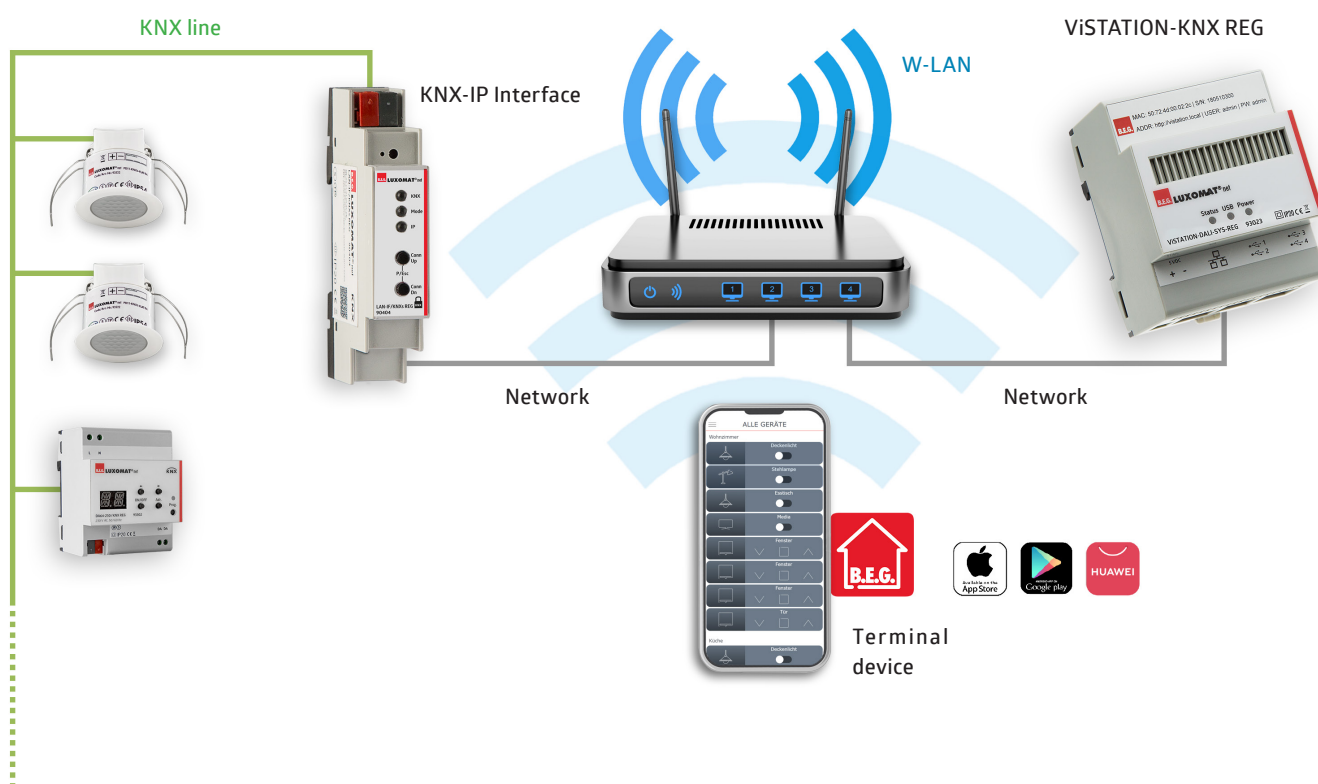







The B.E.G. ViSTATION is not connected to the KNX bus, but is integrated into the building network as a server via LAN. The connection to the KNX system is then realised via an IP interface. The KNX components that are to be controlled via the visualisation are connected to a system via the KNX bus as usual.



ViSTATION-KNX REG

grey

93335

-  5 V DC
-  (4 TE) 90 x 72 x 64 mm
-  max. 5 W
-  IP20 / Class II
-  0 °C to +45 °C
-  Polyamide, UV-resistant

- Virtual Interface Station - The visualisation and remote server for KNX systems
- Plastic housing, 4 widths units (DIN-rail, top hat)
- 1 Ethernet/LAN connection
- 2D floor plan and/or tile view with customer-specific data
- Central visualisation of light, occupancy and error data
- Manual override of individual lighting zones possible
- Manual override via scene function possible
- User and rights management for individual control of specific rooms
- Can be operated via compatible web browser on any user device (smartphone, tablet, PC)
- Including separately enclosed 5VDC/2A power supply for DIN rail mounting (~18 mm)
- Administration access preconfigured for user administration
- Weekly timer
- Astro program, e.g. for sunrise or sunset events

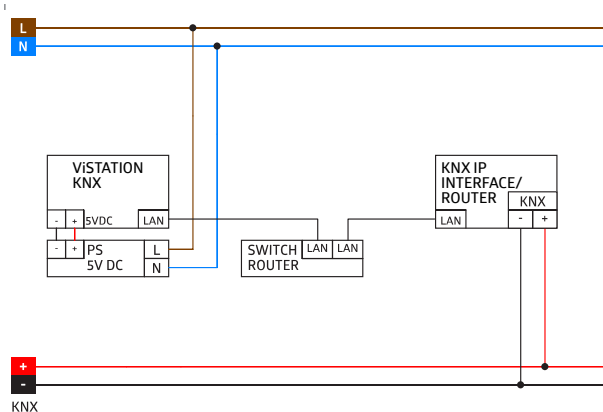

Subject to technical and design changes as well as errors.