

Installation and Operating Instruction

1. Mounting preparations

Work on the 230 V mains supply may only be carried out by qualified professionals or by instructed persons under the direction and supervision of qualified skilled electrical personnel in accordance with electrotechnical regulations.

Disconnect supply before installing!

The LUXOMAT® CdS-T-SM should only be mounted on smooth, vertical surfaces (house walls) facing north.

Please also make sure that any influence on the CdS-T-SM by the connected lighting or by direct sunlight is excluded.

2a. Mounting the plug-in base and making the electrical connections

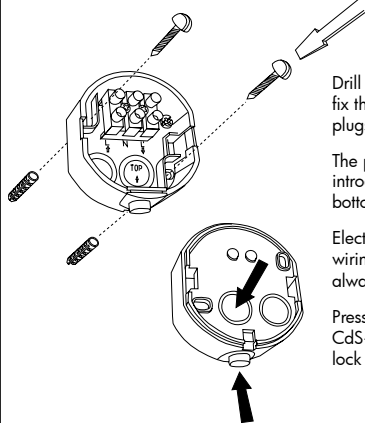

Drill holes with a 6 mm drill and fix the plug-in base with the fitting plugs and screws.

The power cable can be introduced into the base from the bottom or from behind.

Electrical connection according to wiring diagram. The CdS-T-SM is always ready for operation.

Press the photoelectric switch CdS-T-SM onto the plug-in base to lock it there.

2b. Switching inductive loads

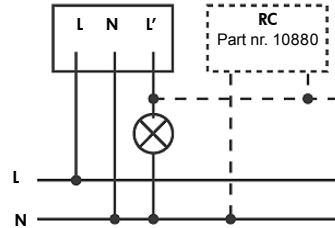

If inductive loads such as for instance relays, transformers, contactors or fluorescent lamps are operated, there will be voltage peaks leading to a repeated switch-on.

By connecting a screening unit, Item No. 10880, side by side to the inductive load, such spikes can be prevented or reduced.

3. Putting into operation / Settings

Self test cycle

The product enters an initial 20-sec. self-test cycle, when the supply is first connected.

Slow flashing of the LED = device is in default setting mode

Rapid flashing of the LED = saved settings are available

For manual settings of the twilight value at the control dial, the device has to be in default setting mode.

To reset the settings, the control dial is put on "Reset" from any lux value. The saved memories will be deleted and the device has to be in default setting mode.

Settings:

1. Twilight value: 200 Lux
2. Summer-/ winter time correction is active
3. Forced shutdown between 1:00 am and 6:00 am is active

Displays (LED) after completed self-check cycle:

no LED display = the surrounding light is brighter than the control knob setting of the twilight value, the connected lighting remains off.

LED lit up = the surrounding light is darker than the control knob setting of the twilight value, the connected lighting is on.

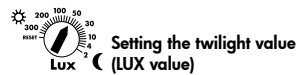

The individual precision adjustment of the switch-on point should be made at the time of day when lighting is intended to be switched on.

Turn the knob (2-300 Lux / moon-sun symbols) until the LED (red) lights up. This is now your switch-on value of the CdS-T-SM (your connected lights), at this value, the LED is always on and the photoelectric switch is activated.

4. Settings carried out using remote control (optional)

Remote control LUXOMAT® IR-CdS-T

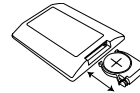

Check Battery:

open battery compartment by pressing the plastic springs together and removing the battery-holder.

Caution:

Settings with remote control supersede the settings of the potentiometers.

Option:

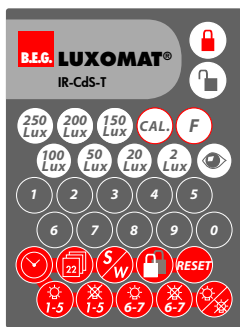

Wall bracket for remote control IR-CdS-T

Settings with remote control

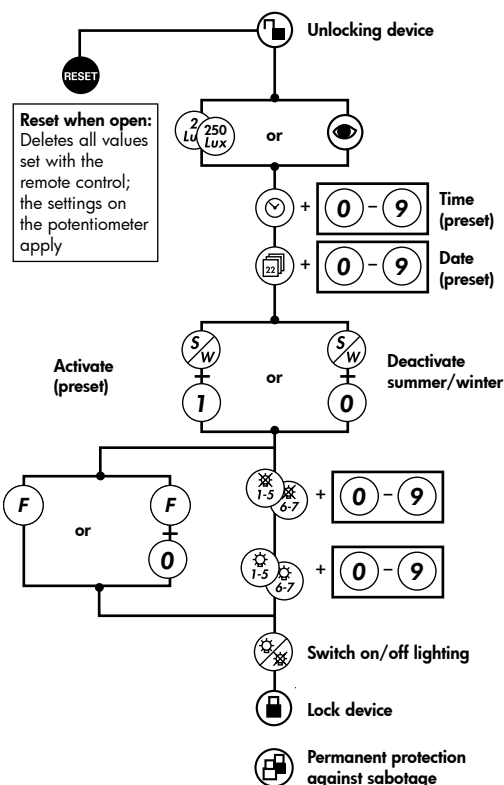

Description of the button functions

- 7 preselected exact switch on and switch-off values (light values) for the connected lights
- Automatic reading and saving of the actual light level
- Automatic timer with calendar (see point 5)
The correct time and date are default.
- Corrections of summer/winter (see point 6)
The correction of summer and winter time is factory-made activated.
- Adjustment of the time for light "OFF" (see point 7)
- Adjustment of the time for light "ON" (see point 7)
- Reset**
Resetting of all functions
- Switch on and off the lighting (see point 8)**
Independently from the ambient luminosity and energy saving period
- Activation of the calibration operation**
- Activation of the forced shutdown between 1:00am and 6:00am**
- Permanent protection against sabotage**
This function blocks the unit permanently (green LED is illuminated). This operating mode can only be activated during the period of 5 seconds after pressing the "lock" button. This status will only permit actuating the function "Light on/Light off".
The procedure for leaving this mode is as follows:
 1. Switch off the current
 2. Apply current for 31 - 59 seconds
 3. Switch of the current again
 4. Apply current
 5. Open detector

5. Set time and day

Set the time

First press the "Unlock" key, then press the "Clock" key. 
Now the LED flashes rapidly.
After each character received, the relay/light will switch.
After the 4th character the relay/light will switch and the LED will flash less rapidly.

Set day / calendar

First press the "Unlock" key, then press the "Calendar" key. 
Now the LED flashes quickly. Enter data in the following format:

days	(DD)	(01 - 31)		
months	(MM)	(01 - 12)		
years	(YY)	(00 - 99)		
Weekdays	(Wd)	(1 - 7)		
e.g.:	08.	March	2002	Friday
	DD	MM	YY	Wd
	08	03	02	5

After each character received, the relay/light will switch.
After the 7th character the relay/light will switch and the LED will flash less rapidly.

6. Activation of forced shutdown

With forced shutdown the light fitting will stay switched off between 1 am and 6 am. Any additional programming during this time period is not necessary. Beyond this time period, the device is switching the light depending on brightness.

To adjust the forced shutdown mode, please push the "F" button, when the device is unlocked. The LED starts flashing quickly. Afterwards please choose "1" for activation or "0" for deactivation of the feature.

When the forced shutdown is deactivated, the photo electric switch will switch the lights, depending on the adjusted energy saving periods. (chapter 10).

7. Correction for summer/winter

The change to daylight saving time is already activated in the factory.

Deactivate daylight saving time by pressing the "S/W" key, then the "0" key. The function is **activated** by pressing the "S/W" key, then the "1" key.





8. Recalibration of the system time

The CdS-T-AP can recalibrate the system time intelligently. The device uses a calculation to reduce the likelihood of the system clock deviating from real time. For the CdS-T-AP to use the correct value to calculate the system time the following conditions are necessary:

- The device is in operation for longer than 1 month.
- The system time deviates at least 2 minutes and maximum of 5 hours from the real time.

If one or both conditions are not applied, the calibration operation is deactivated.

9. Calibration of system time with remote control IR-CdS-T

-  Unlocking device
-  starting calibration operation (LED flashes quickly)
-  Input of the current time in hh:mm (24 h display)
-  Locking device

After every received digit, the relay will switch the light fitting and the LED indicator will flash slower.

When the calibration is successful, it is acknowledged by the LED indicator flashing quickly for approx. 10 seconds.

Note: The calibrations value will reset by reprogramming of date and time. (chapter 5)

10. Energy saving periods

Energy saving periods

The appliance has two programmable energy saving periods:
a) for day 1 (Monday) – day 5 (Friday)
b) for day 6 (Saturday) – day 7 (Sunday)

Setting the time for "Light OFF"

First press the "Unlock" key, then press the "Light OFF 1-5" or "Light OFF 6-7" key. 
Now the LED flashes rapidly.
Enter the data in the format of 10/1 hours and 10/1 minutes. Only a time between 12:00 - 23:59 can be entered.
After each character received, the relay/light will switch.
After the 4th character the relay/light will switch and the LED will flash less rapidly.

Setting the time for "Light ON"

First press the "Unlock" key, then press the "Light ON 1-5" or the "Light ON 6-7" key. 
Now the LED flashes rapidly.
Enter data in the hours : minutes format e.g. 04:15. Only times between 00:00 – 11:59 can be entered.
After each character received, the relay/light will switch.
After the 4th character the relay/light will switch and the LED will flash less rapidly.

Note: If the energy saving period is not required, the "OFF" time 1-5 or 6-7 must be at 23:59 and the "ON" time 1-5 or 6-7 must be 00:00.

Alternatively, a "RESET" will erase all saved data, and after that all of the factory settings are active again (see chapter "RESET").

11. Activation "Switch on/off lighting"

Because of the sabotage protection the function "Light off" is deactivated in the factory. When required it must be activated again (The "Light on" function is always active):

1. Mains to be disconnected
2. Mains to be connected - a self test cycle of 20 sec. starts (the LED is flashing).
3. Activation/deactivation of the function "Light Off" can be done only during the self testing cycle.

 For activation of the function "Light OFF" the button "Switch on/off lighting" must be pressed during the self testing cycle (the LED will flash quickly).

 For deactivation "Light OFF" the button "Reset" must be pressed during the self testing cycle (the LED will flash slowly).

Caution: The implementation of "Reset" with potentiometers (see point 3) or with remote control does not influence the activation/deactivation of the function "Light OFF".

12. Technical data

Power supply: 230V~ ±10%
Switching power: 2300W cos φ = 1 / 1150VA cos φ = 0.5
Function "energy saving": "Light off" 5 hrs. during night – with IR-CdS-T only
Light values: 2 - 300 Lux (Potentiometer),
2 - 250 Lux (IR-CdS-T)
Ambient temperature: -25°C to +50°C
Degree of protection/class: IP54 / II
Dimensions: 69 x 65 x 52 mm

 **Declaration of Conformity:** The product complies with the low voltage recommendation 2006/95/EC and the EMV recommendation 2004/108/EC.

13. Article / Part-Nr. / Accessory

LUXOMAT® CdS-T-SM	92367
LUXOMAT® Remote control: IR-CdS-T (incl. wall bracket)	92368

14. Dimensions

